

xtremeDB: CANBUS

User Manual



Table of Contents

Document Revision History	3
Description of Manual and Product	3
Safety Information	4
Part Number Structure	5
Module Overview	6
Technical Data	6
Installation and Maintenance Notes	7
J1939 LEDs	8
CANopen LEDs	9
Fault Diagnostics	10
Configuring the Baud Rate	11
Configuring the Node Source Address	11
Powering the Module	12
Module Pinouts	16
I/O Specifications	17
Variant-Specific Information	17
Input Operation	19
Counter Operation	20
Encoder Operation	21
Output Operation	22
PWM(i) Operation	22
Status Messages	23
J1939 Configuration	24
Configuration Process	24
Configuration Notes	27
Command Message Details	28
PGNs Used	41
PGN Message Details	42
CANopen Configuration	56
Configuration Notes	56
Use of Index	56
Communication Profile	56
Process Data Objects (PDO)	56
Store/Restore Parameters	57
Emergency Message Format	57
Heartbeat	57
Index Reference by Variant	58
Recieve PDO	59
Transmit PDO	59
Communication Segment	60
Manufacturer Segment	69
Device Profile Segment	85
Programming/Firmware Notes	94
Accepted Accessories	94
Warranty and Liability Claims	95
Message Location Within This Document	96
Glossary	99
Mode Operation Examples	100

Document Revision History

- 01 Initial release, January 2022
- 02 Fixed Command Message 82, minor edits, March 2022

Description of Manual

This user manual is a resource to users for correct maintenance and operation of this product. The text, illustrations, diagrams, and examples used in this manual exist solely for the purpose of explaining the operation and usage of *xtremeDB: DP-34044-1, DP-34044-2, DP-34044-3, DP-34044-4, DP-34044-5* modules. If you have any further questions regarding the installation and set-up of the equipment described in this manual, please do not hesitate to contact us at dptech@murrinc.com. Data Panel Corporation and Murrelektronik reserve the right to make changes or modifications to this manual without prior notice.

Description of Product

xtremeDB® is the ultimate mobile solution for both on-highway and off-highway system applications with I/O signal and power distribution needs of up to 52 Amps. This family of distribution blocks takes advantage of DEUTSCH connections to achieve IP67/IP69K ratings, and pin-level LED diagnostics make for improved field serviceability. In addition to short circuit and overcurrent protection, a complete set of fault codes is shown via port- and module-level LED's, and these codes that are broadcasted on the network can enable fault messages on the display so operators can quickly identify possible problems on the machine. With these blocks installed in your vehicles, spiderweb harnesses will be eliminated to significantly reduce your wiring efforts, and your cable runs to each device will be considerably shorter.

The three communication types of the CANBUS family include CAN J1939, CANopen, and DPLogic, the latter of which has a built-in controller. With DPLogic, the block becomes a main controller/PLC for either the system or for distributed logic. When utilizing distributed logic, you can process commands for sub systems, which reduces the load on the CANBUS.

The trademark DEUTSCH is owned by the TE Connectivity Ltd. family of companies.

Applicable Data Sheets:

DP-34044-1-000_db_e
 DP-34044-1-200_db_e
 DP-34044-2-000_db_e
 DP-34044-2-200_db_e
 DP-34044-3-000_db_e
 DP-34044-3-200_db_e
 DP-34044-4-000_db_e
 DP-34044-4-200_db_e
 DP-34044-5-000_db_e
 DP-34044-5-200_db_e

Applicable Installation Manuals:

DP-34044-1-000_ina_10
 DP-34044-1-100_ina_10
 DP-34044-1-200_ina_10
 DP-34044-2-000_ina_10
 DP-34044-2-200_ina_10
 DP-34044-3-000_ina_10
 DP-34044-3-200_ina_10
 DP-34044-4-000_ina_10
 DP-34044-4-200_ina_10
 DP-34044-5-000_ina_10
 DP-34044-5-100_ina_10
 DP-34044-5-200_ina_10

Applicable Software Quickstart Guides

Block Tool
 DPLoader
 DPNPlayer

Safety Information

TARGET GROUPS

This manual addresses itself exclusively to qualified and trained technicians knowledgeable in the safety standards of automation technology. Only a qualified, trained technician knowledgeable in the safety standards of the mobile industry may perform configuration, installation, set-up, maintenance, and testing of the equipment.

DESIGNATED USE

The input/output modules of the xtremeDB series are designated for use only in those areas as described in this manual. Strict adherence to the data specified in this manual and other published documentation must be ensured. The products have been developed, manufactured, tested, and documented in compliance with safety codes noted in the data sheets. The equipment poses no danger to operating personnel or material if configuration, assembly, and operation are performed in compliance with the stated handling and safety regulations. Unqualified intervention in the hardware and software of our equipment, disregard of warning labels found on the equipment, or non-observance of the information in this manual can result in injury or serious damage to man and/or material. Any application or usage beyond and above this shall be regarded as non-designated.

REGULATIONS

Current safety and accident prevention laws valid for a specific application must be observed in the configuration, installation, setup, and maintenance and testing of the equipment.

1. The designated function of the module is guaranteed only if the conditions for installation, system extension, operation, and maintenance are complied with and the housing is fully installed. Any modifications to the housing are not allowed.
 - i. The module described is installed as a subcomponent in a system. The safety of this system is the responsibility of the creator. The system manufacturer is obliged to carry out a risk assessment, and from this to prepare and enclose documentation in accordance with the legal and normative requirements for the operator and the user of the system. This must contain all necessary information and safety instructions for the operator, user and, if applicable, service personnel authorized by the system manufacturer.
 - ii. Read this document before putting the product into operation; keep this document for the duration of product use.
2. Only system accessories and cables that meet the requirements and regulations for safety, electromagnetic compatibility and, where applicable, telecommunications transmission equipment and specifications are allowed. The installation of other accessories may violate these requirements and regulations or damage the equipment. Information concerning the type of authorized system extensions and cables can be obtained from your Murrelektronik distributor or taken from this manual.
3. Welding may damage the integrity of the module. Use good welding practices.
 - i. Damage or impairment of electrical safety may occur due to overcurrent, welding spatter, and contamination from welding work.
 - ii. Welding work on the chassis frame may only be carried out by qualified personnel.
 - iii. Remove and cover the positive and negative terminals of the batteries.
 - iv. Disconnect the module with all contacts from the onboard power supply before welding on the vehicle or on the system.
 - v. Connect the ground clamp of the welding device directly to the part to be welded.
 - vi. Do not touch the module and electrical lines with the welding electrode or the ground terminal of the welding device.
 - vii. Protect the module, including all connection plugs and all connection lines, against welding spatter and other contaminants.
4. This product is designed and manufactured to assure protection against damage and hazards if designated usage and proper maintenance are observed.
 - i. This product must be suitable without restriction for the applications and environmental conditions concerned. **This product is not a safety component or appropriate for potentially explosive environments.** Only use the product as intended. Failure to observe application instructions or technical specifications may result in damage to property and/or personal injury.

END USER LICENSE

EXCLUSION OF INCIDENTAL, CONSEQUENTIAL, AND CERTAIN OTHER DAMAGES:

To the maximum extent permitted by applicable law, in no event shall Data Panel or Murrelektronik be liable for any special, incidental, indirect, or consequential damages whatsoever (including, but not limited to, damages for loss of profits or confidential or other information, for business interruption, for personal injury, for loss of privacy, for failure to meet any duty including of good faith or of reasonable care, for negligence, and for any other pecuniary or other loss whatsoever) arising out of or in any way related to the use of or inability to use the software product, the provision of or failure to provide support services, or otherwise under or in connection with any provision of this End User License, even in the event of the fault, tort (including negligence), strict liability, breach of contract or breach of warranty of Data Panel or Murrelektronik, or any supplier, and even if Data Panel or Murrelektronik or any supplier has been advised of the possibility of such damages.

EXAMPLE OF SYMBOLS

Use of Attention Signs

Notes containing important information are specially marked. These are illustrated as follows:



Attention text...

Use of Danger Signs

Danger signs are indicated by text and a corresponding symbol inside of a frame:

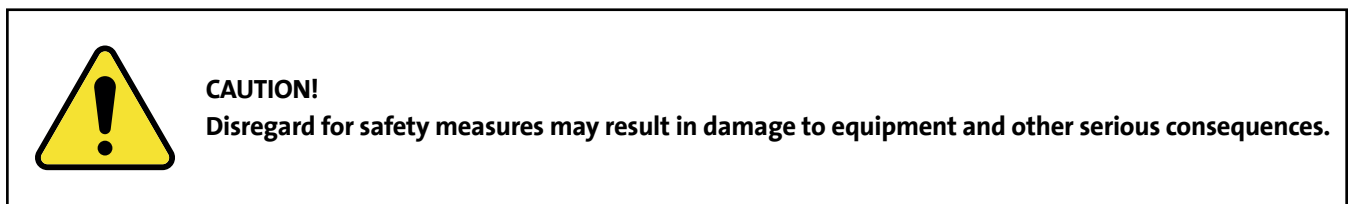

Part Number Structure

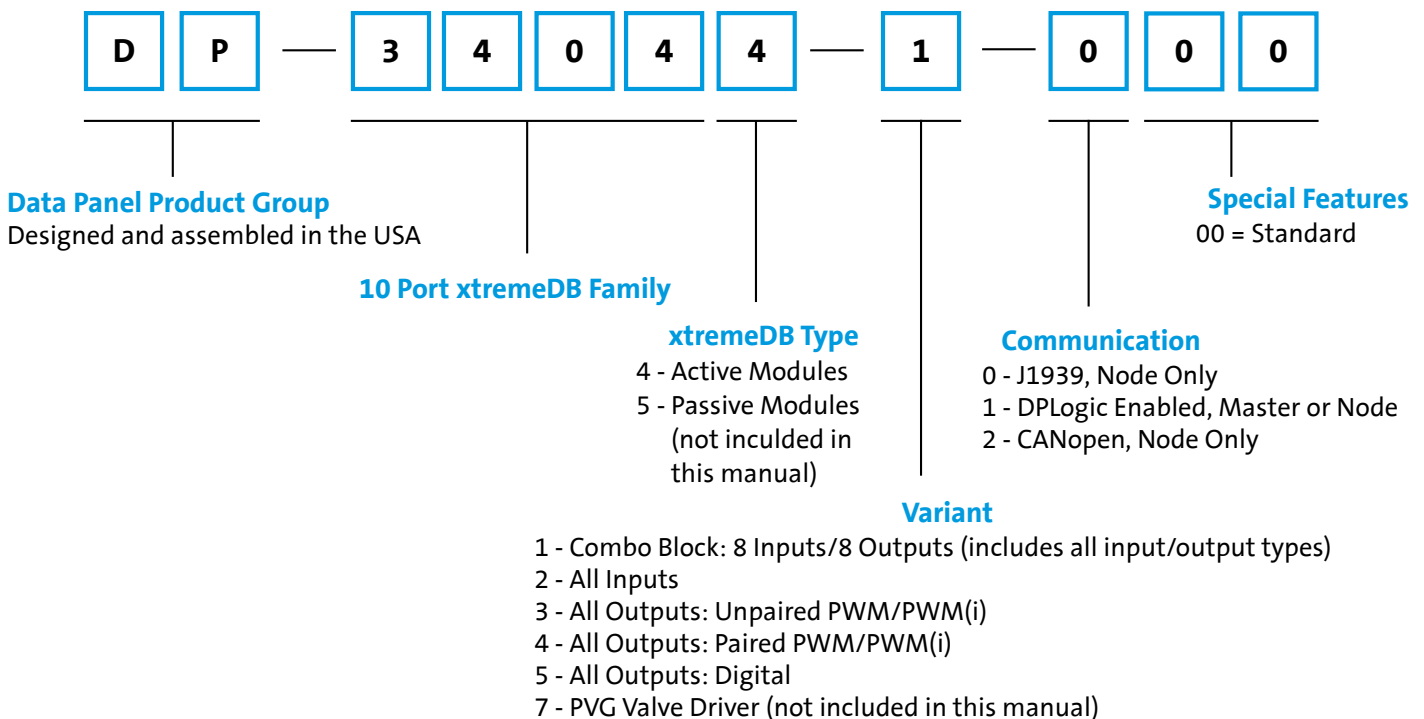

Example: **DP-34044-1-000** is a J1939 standard combo unit.
 First generation part numbers will be updated by adding “-000” to indicate standard J1939 modules.

Module Overview

TECHNICAL DATA

P0: Output power and configuration

Module power and CAN communication

DEUTSCH connectivity for sensors, valves and other components

LEDs for visual diagnostics at the ports

IP69K with Murrelektronik MDC cables



| AT A GLANCE

- 6 CANBUS Variants (5 included in this manual)
- Configurable Inputs and Outputs
 - Digital, 0-5V DC, 0-10V DC, 4-20 mA, counter, frequency, encoder, ratiometric, ground input
 - Digital, PWM, PWM(i)
- Two I/O Pins per Port, 16 Total Inputs/Outputs
- Current Rating
 - Up to 52A per module
 - Up to 10A per output
- Works in 12 and 24V DC systems
- Operating Temperature Range: -40 to 80°C
- Size: 10.4" (L) x 3.8" (W) x 1.3" (D)
- Optimized Applications and Firmware

See pages 17-18 for technical details specific to each variant.

Installation	(3) M5 x 1 screws
Communication	2 non-isolated J1939 ports (250kb & 500kb)
Voltage Range	8-32V DC
Operating Temperature	(-40 to 80°C)
Storage Temperature	(-40 to 85°C)
Protection	IP67 (IP69K with Murrelektronik MDC cables)
Number of Ports	8
Total Number of I/O	16
Input Diagnostics	Short Circuit, Over Voltage
Output Diagnostics	Short Circuit and Overcurrent
Analog Resolution	12 bit, 1% Full Scale Accuracy

INSTALLATION AND MAINTENANCE NOTES

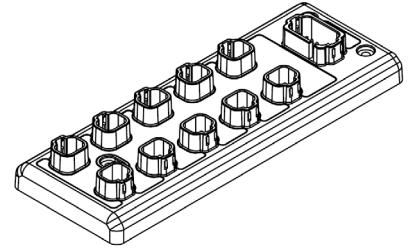
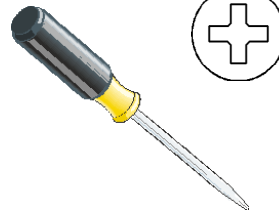
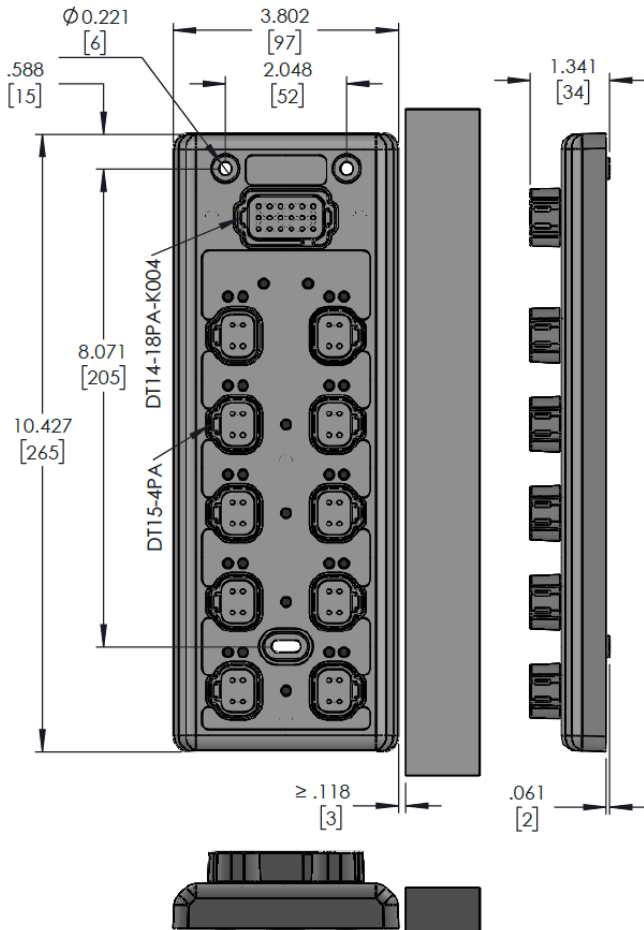

Installation

The xtremeDB blocks can be mounted directly on an installation panel or on a machine. The module features three mounting holes, which each accept M5 screws, for this purpose. The mounting surface must be smooth and flat to prevent mechanical stress in the module housing. Prevent torsional forces or mechanical loads from acting on the housing.

- Power connections should be fused externally to the block.
- The module must not exceed or fall below the specified tolerances.
- Select and install connecting cables in such a way that capacitive and inductive interference does not impair the system.
- Avoid contamination before and during installation until the protection rating is ensured by plugs or dummy plugs.
- Secure the module against misuse and accidental use.

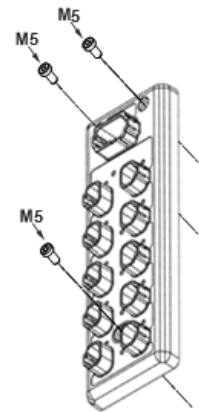

See Safety Information for detailed notes on safe application of this product.

Servicing and Cleaning

The module itself is maintenance-free. No inspection and maintenance work is necessary during operation. However, a regular check of your overall system should be included in the maintenance schedule of your machine in order to detect possible defects caused by external influences at an early stage.

- Clean soiled contacts only with oil-free compressed air or with alcohol and a lint-free cloth. Do not use contact spray.
- When using aggressive mediums near the block, check the application-specific material resistance. This product has good chemical and oil resistance; refer to data sheet for material specifications.



Proper installation and operation of the xtremeDB blocks requires the use of all ground connections. This includes Ground (A) for module power and Ground (B) for port power on the 18 pin configuration and power plug.



All unused ports should be plugged. All unused pins should be plugged with a DEUTSCH #114017 sealing plug to maintain the IP67 rating.



- PWR LED (Blue):** Power status
- FLT LED (Red):** Fault status
- STAT LED (Green):** Module status
- COM LED (Green):** Communication status

PORT I/O LED (Yellow):
 Left LED = Signal A
 Right LED = Signal B

- Status**
1. Steady On = Output/Input is on
 2. Flashing On (Output Port) = Output has a fault
 3. Flashing On (Input Port) = Input is pulsing, shorted, or over voltage
 4. Both flashing with FLT LED indicates a sensor power fault

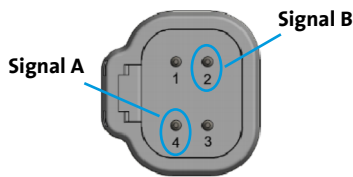

- Bus Power (Blue):**
 P1 = Power for ports 1-8 (DP-34044-5)
 OR
 P1 = Power for ports 1 & 2 (DP-34044-1, -3, -4)
 P2 = Power for ports 3 & 4 (DP-34044-1, -3, -4)
 P3 = Power for ports 5 & 6 (DP-34044-3, -4)
 P4 = Power for ports 7 & 8 (DP-34044-3, -4)

J1939 LED INDICATION

During start up, all LEDs will turn on for 3-5 seconds to verify that they are working (bulb test).

Short = ON 500ms and OFF 500ms
 Long = OFF defined as 2.0 s

COM LED (Green): Communication Status

ID	Fault Description	ON	OFF
n/a	Bootload Mode	Traffic on Bus	N/A
C0	Valid Communication Network	ON	
C1	Source Address (SA) Arbitration	1 Short	1 Long
C2	CANBUS Hardware Fault	2 Short	
C3	Output Control Message Missing	3 Short	
C4	DM13 Detected*	4 Short	

* See J1939-73 diagnostics: Another device has requested module to stop broadcasting.

FLT LED (Red): Fault Status

ID	Fault Description	ON	OFF
F0	Bootload Mode	1 Short	1 Short
F1	Output Overcurrent Fault	1 Short	1 Long
F2	Low Voltage Warning	2 Short	
F3	Over Voltage Warning	3 Short	
F4	Over Temperature Warning	4 Short	
F5	Input Over Voltage	5 Short	
F6	Not Used	-	
F7	Internal Module Fault	7 Short	

STAT LED (Green): Module Status

ID	Fault Description	ON	OFF
S0	Configuration Saved	ON	



The module may be online before the end of the bulb test; I/O may be active during the bulb test.

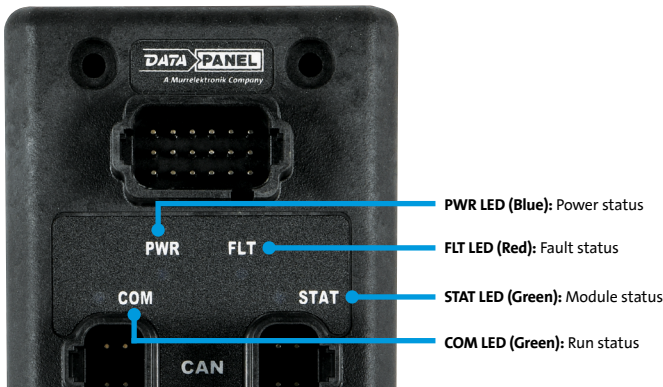

STAT LED (Green): Module Status
Indicates module errors.

ID	Module Error Description	ON	OFF
F0	Bootload Mode	1 Short	1 Short
F1	Output Overcurrent Fault	1 Short	1 Long
F2	Low Voltage Warning	2 Short	
F3	Over Voltage Warning	3 Short	
F4	Over Temperature Warning	4 Short	
F5	Input Over Voltage	5 Short	
F6	Not Used	-	
F7	Internal Module Fault	7 Short	

NOTE: The definitions for Short and Long, in the case of the STAT LED on CANopen blocks, follow the J1939 definition, as defined below:

Short = ON 500ms and OFF 500ms
Long = OFF defined as 2.0 s

CANopen LED INDICATION

During start up, all LEDs will turn on for 3 seconds to verify that they are working (bulb test). The function of the LEDs is defined according to the CiA standard DR 303-3 V 1.4.0

Flickering = ON 50ms and OFF 50ms
Blinking = ON 200ms and OFF 200ms
Flash = ON 200ms and OFF 200ms
Pulse Width is ± 50 ms

COM LED (Green): Run Status

Indicates the status of the CANopen network state machine. LED will be off while the device is executing a reset.

LED Activity	State	ON
Flickering	Auto Bitrate/LSS	The auto-bitrate detection is in progress or LSS services are in progress (alternately flickering with error LED)
Blinking	PRE-OPERATIONAL	The device is in state PRE-OPERATIONAL
Single Flash	STOPPED	The device is in state STOPPED
On	OPERATIONAL	The device is in state OPERATIONAL

FLT LED (Red): Fault Status

Indicates the status of the CAN physical layer and errors due to missing CAN messages (sync, guard or heartbeat).

LED Activity	State	Description
Off	No error	The device is in working condition
Flickering	AutoBitrate/LSS	The auto-bitrate detection is in progress or LSS services are in progress (alternately flickering with run LED) (See NOTE.)
Blinking	Invalid configuration	General configuration error
Single Flash	Warning limit reached	At least one of the error counters of the CAN controller has reached or exceeded the warning level (too many error frames)
Double Flash	Error control event	A guard event (NMT-slave or NMTmaster) or a heartbeat event (heartbeat consumer) has occurred
Triple Flash	Sync error	The sync message has not been received within the configured communication cycle period time out (see object dictionary entry 1006h)
Quadruple Flash	Event-timer error	An expected PDO has not been received before the event-timer elapsed
On	BUS off	The CAN controller is BUS off

FAULT DIAGNOSTICS

- When multiple faults are present, shown faults via the LEDs do not prioritize fault info; LEDs only show the most recent fault.
- Resetting an output fault will require cycling the module power unless the Controller Mode Output Reset is enabled. If the Controller Mode Output Reset is enabled, the fault will be reset when the output is turned off, limited to 5 times before a module power cycle will be required. An output fault will not affect the other outputs on the module.
- For a 12V DC system, over voltage is defined as an input voltage > 18V DC, low voltage is defined as < 11V DC.
- For a 24V DC system, over voltage is defined as an input voltage > 32V DC, low voltage is defined as < 20V DC.

Fault Description	Fault Indication	Possible Failure Conditions	Suggested Solutions
Low Voltage Warning	2 short, 1 long on FLT LED	POWER voltage is less than 11.0 V DC for 8s	Extended operation below the low voltage threshold WILL NOT damage the module. Low voltage indicates the condition of the system.
Over Voltage Warning	3 short, 1 long on FLT LED	POWER voltage is greater than 32 V DC for 8s	Extended operation above the high voltage threshold MAY CAUSE PERMENANT DAMAGE to the module. Reduce system voltage.
Over Temperature Warning	4 short, 1 long on FLT LED	TEMP reading is greater than 80°C for 8s	Additional module cooling may be required for the application to avoid failure due to extended operation outside of the specified temperature range.
Input Over Voltage	5 short, 1 long on FLT LED	Incorrect voltage range may have been selected for an analog input or Battery voltage may be exceeding the maximum rating for the device	When an analog input over voltage has been detected, the module will adjust the selected analog input voltage range to protect itself from damage. Momentary voltage spikes above the specified voltage range of the device MAY CAUSE PERMENANT DAMAGE .
Internal Module Failure	7 short, 1 long on the FLT LED	Internal hardware failure	Cycle power.
Bootload Mode	1 short, 1 short on FLT LED and rapid flashing on COM LED	Under normal operation, the COM and FLT LEDs will flash the bootload pattern during the bootload process. Bootload mode will persist until the bootload cycle has fully completed. I/O will not be functional until the device has exited bootload mode.	If CAN communication or power was removed from the device during bootload, power cycle the device and restart the bootload process. Ensure the proper firmware is being loaded for your device version. Attempting to load a DP-34044-1-000 with DP-34044-1-100 firmware will lock the device in bootload mode until the appropriate DP-34044-1-000 firmware has been reloaded into device.
Source Address Arbitration	1 short, 1 long on COM LED	The device has detected an identical source address already on the CANBUS	Check that P0 has the appropriate jumpers with good connections. Ensure a power cycle was performed after any address changes were applied. Source addresses must be unique on each CANBUS.
CANBUS Hardware Fault	2 short, 1 long on COM LED	Open CANBUS with either CANH or CANL, or both, not connected	Ensure CANH and CANL are connected to the correct pins on both ends of the harness. Ensure the BUS is properly terminated with 120 Ohm resistors according to the J1939 standard. Check terminating resistors and CANH, CANL connections.
Output Control Message Missing	3 short, 1 long on COM LED	The block is not receiving Command 0x51h	Message 0x51h must be received every 200mS or this fault will continue to occur.
DM13 Detected	4 short, 1 long on COM LED	The module has detected the DM13 start/stop broadcast message. All CAN traffic from the device is silenced until it no longer detects the DM13 message.	Stop sending the DM13 message for the block to begin sending CAN messages again.
Output Overcurrent	1 short, 1 long on FLT LED	An output is requesting more than the specified current limit of the output	Inspect wiring harness for damage. Inspect for seized loads, ect.
Short Circuit (DP-34044-5 only)	5 short, 1 long on FLT LED	An output short circuit has been detected	Inspect wiring harness for damage. Inspect for seized loads, ect.

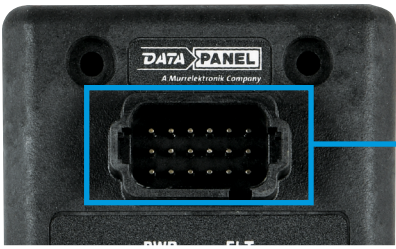

P0: Configuration and Output Power

A key feature of the xtremeDB 10 port version is the ability to hardware set the address and baud rate via jumpers in the 18 pin (P0) connector. This allows for easy field replacements with no need to pre-configure those settings.

CONFIGURING THE BAUD RATE

Configuration of the baud rate is done using pins 1 and 7 of the Power and Configuration plug shown below. If connecting to a 250kb network no jumpers are required. If connecting to a 500kb network, jumper pin 1 to pin 7.

CONFIGURING THE NODE SOURCE ADDRESS

Offset	Jumper Wire				J1939 Source Address		CANopen Node ID
	CNFG1-A/B	CNFG2-A/B	CNFG3-A/B	CNFG4-A/B			
0					(0xE0h)	224	1
1	X				(0xE1h)	225	2
2		X			(0xE2h)	226	3
3	X	X			(0xE3h)	227	4
4			X		(0xE4h)	228	5
5	X		X		(0xE5h)	229	6
6		X	X		(0xE6h)	230	7
7	X	X	X		(0xE7h)	231	8
8				X	(0xE8h)	232	9
9	X			X	(0xE9h)	233	10
10		X		X	(0xEAh)	234	11
11	X	X		X	(0xEBh)	235	12
12			X	X	(0xECh)	236	13
13	X		X	X	(0xEDh)	237	14
14		X	X	X	(0xEEh)	238	15
15	X	X	X	X	(0xEFh)	239	16

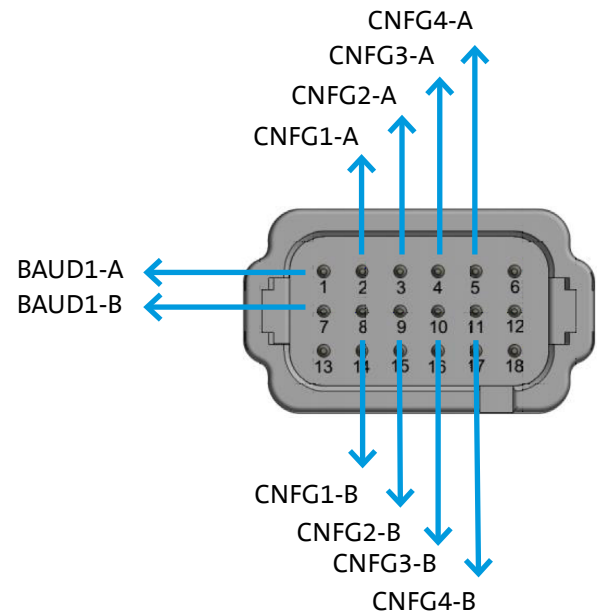

The J1939 Source Address (SA) is configured by jumpering the matching Config-A to Config-B. The J1939 SA starts with a base address of **224 (0xE0h)** with no jumpers installed. In CANopen the default Node ID is 1, and all other Node IDs are 1 + the offset. A power cycle is required when changing the SA or Node ID. If, on power up, a source address on the network duplicates that of the module, it will stay in address arbitration mode and will not function; it will cause a COM fault.



All devices on the same CAN network must have the same baud rate.

DP-34044-1-XXXX I/O Diagram

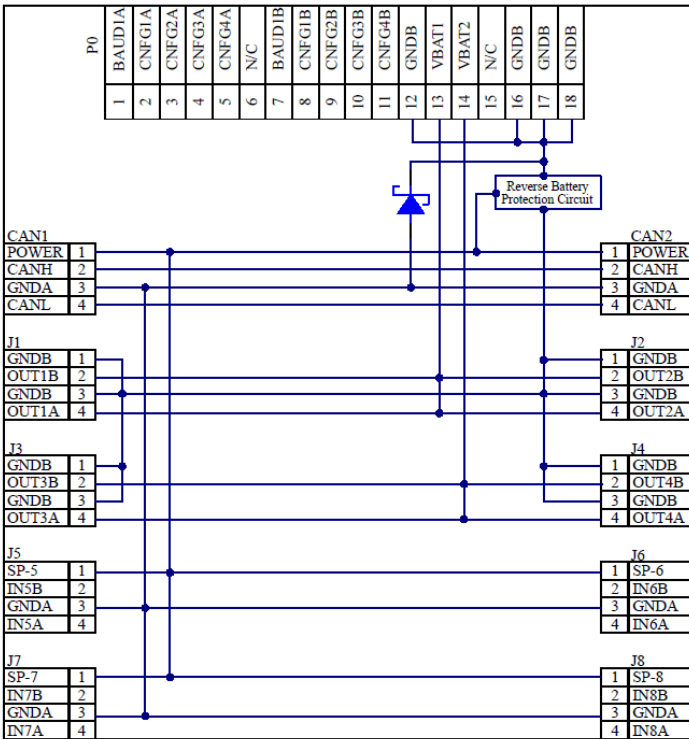

POWERING THE MODULE: DP-34044-1

The module receives its power from the CAN ports. Module power is limited to 13 amps and is used to power both input ports and connected modules down the line.

- | | |
|------------------|------------------|
| Power | CAN |
| Pin 1 = POWER | Pin 2 = CAN High |
| Pin 3 = Ground A | Pin 4 = CAN Low |

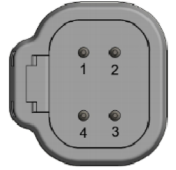

Module Power (POWER)

This circuit has separate power and ground supplied by the CAN port (Ground A).

Sensor Power

The module monitors Port Sensor Power current and shuts off the sensor power in a port if the maximum current exceeds 3 amps per port. Both short circuit and overcurrent protection is provided.

Port 5 - Port 8 = Power, 3 amps each

POWERING THE OUTPUTS

BUS Power (P1, P2)

The module monitors Power BUS current and will shut off all applicable outputs if the maximum current exceeds 13 amps per BUS. Short circuit protection is provided.

P1 BUS = Ports 1 & 2 power, 13 amps

P2 BUS = Ports 3 & 4 power, 13 amps



CAN Ports: Non-Isolated

Input and Output Ports



All Ground (A) connections are internally connected and are isolated from Ground (B).



The connection between CAN1 & CAN2 for the power feed is not fused (protected from short circuit current). During installation, the module power wiring on CAN1 & CAN2 pin 1 should have a 13A fuse before the modules.



Module power should NOT be used to power any output devices.

DP-34044-2-XXX I/O Diagram

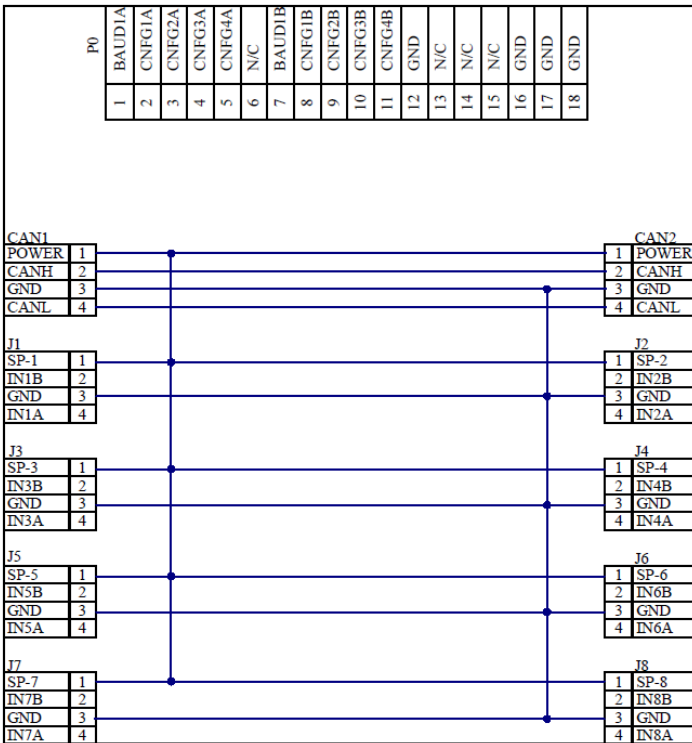

POWERING THE MODULE: DP-34044-2

The module receives its power from the CAN ports. Module power is limited to 13 amps and is used to power both input ports and connected modules down the line.

Power

Pin 1 = POWER
Pin 3 = Ground A

CAN

Pin 2 = CAN High
Pin 4 = CAN Low

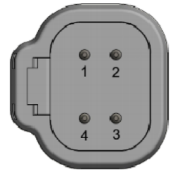

Module Power (POWER)

This circuit has separate power and ground supplied by the CAN port (Ground A).

Sensor Power

The module monitors Port Sensor Power current and shuts off the sensor power in a port if the maximum current exceeds 3 amps per port. Both short circuit and overcurrent protection is provided.

Port 1- Port 8 = Power, 3 amps each

POWERING THE OUTPUTS

BUS Power

No power connections are necessary in P0.



CAN Ports: Non-Isolated

Input Ports



Module and sensor power is provided via the CAN port.



The connection between CAN1 & CAN2 for the power feed is not fused (protected from short circuit current). During installation, the module power wiring on CAN1 & CAN2 pin 1 should have a 10-12A fuse before the modules.



Module power should NOT be used to power any output devices.

DP-34044-3-XXXX I/O Diagram

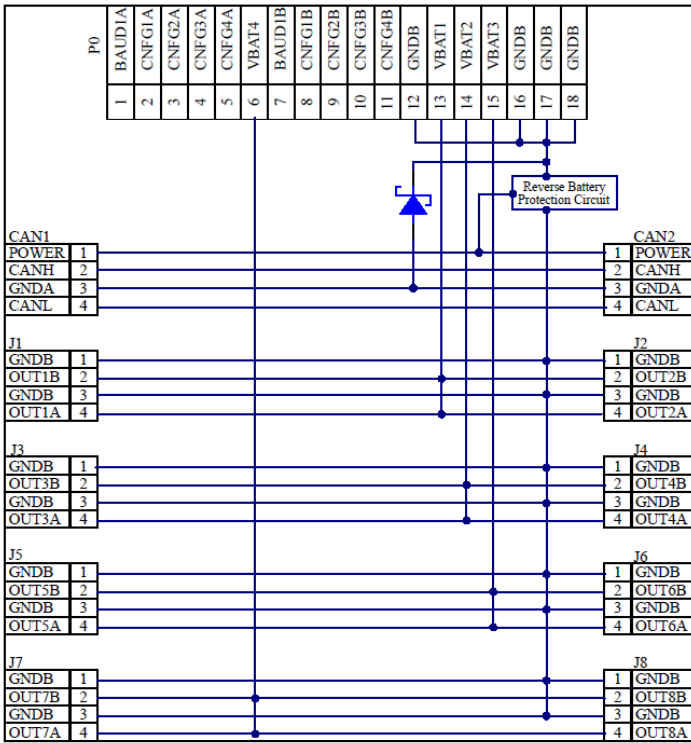

DP-34044-4-XXXX I/O Diagram

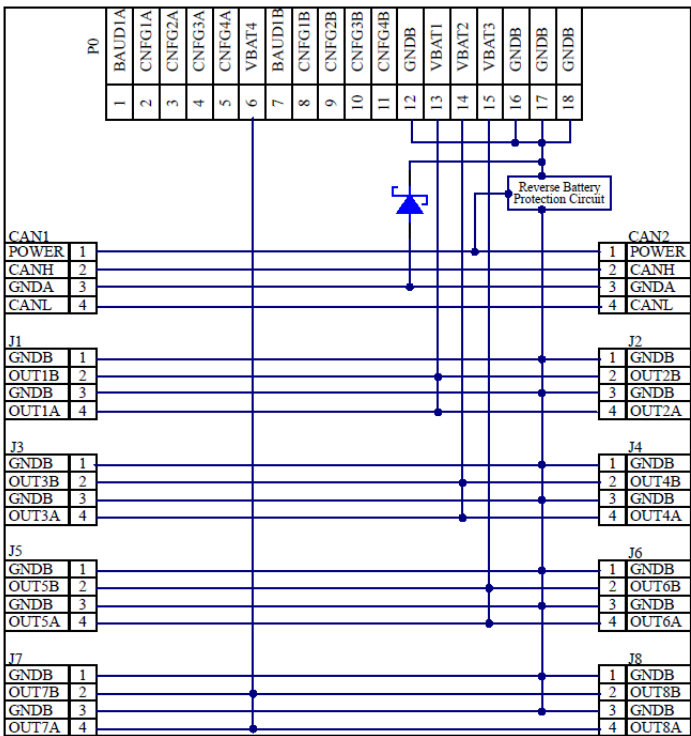

POWERING THE MODULE: DP-34044-3, -4

The module receives its power from the CAN ports. Module power is limited to 13 amps and is used as passthrough to connected modules down the line.

- Power**
Pin 1 = POWER
Pin 3 = Ground A
- CAN**
Pin 2 = CAN High
Pin 4 = CAN Low

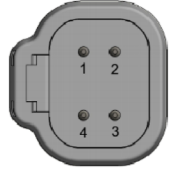

Module Power (POWER)

This circuit has separate power and ground supplied by the CAN port (Ground A).

POWERING THE OUTPUTS

Output Power (BATTERY P1-P4)

The module monitors Power BUS current and will shut off all outputs if the maximum current exceeds 13 amps per BUS. Short circuit protection is provided.

DP-34044-3 and DP-34044-4

- P1 = Ports 1 & 2 power, 13 amps.
- P2 = Ports 3 & 4 power, 13 amps.
- P3 = Ports 5 & 6 power, 13 amps.
- P4 = Ports 7 & 8 power, 13 amps.



CAN Ports: Non-Isolated

Output Ports



The connection between CAN1 & CAN2 for the power feed is not fused (protected from short circuit current). During installation, the module power wiring on CAN1 & CAN2 pin 1 should have a 10-12A fuse before the modules.



Module power should NOT be used to power any output devices.

DP-34044-5-XXXX I/O Diagram

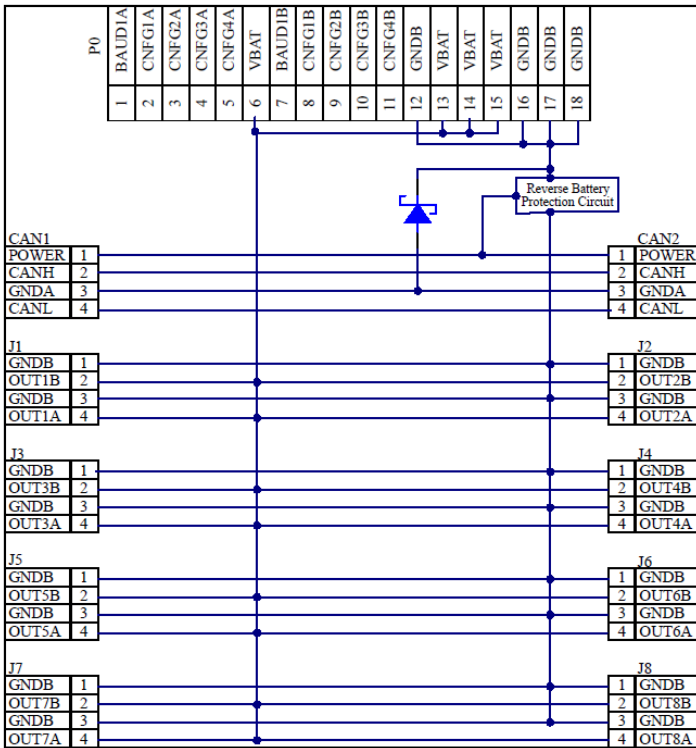

POWERING THE MODULE: 34044-5

The module receives its power from the CAN ports. Module power is limited to 13 amps and is used as passthrough to connected modules down the line.

Power

Pin 1 = POWER
Pin 3 = Ground A

CAN

Pin 2 = CAN High
Pin 4 = CAN Low

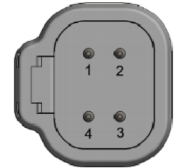

Module Power

This circuit has separate power and ground supplied by the CAN port (Ground A).

POWERING THE OUTPUTS

BUS Power

The module monitors Power BUS current and will shut off all outputs if the maximum current is exceeded. Short circuit protection is provided.

DP-34044-5

P1 = All ports power, 13 amps.

P2, P3, and P4 connections can deliver additional power on the P1 BUS.

All four output power pins are connected internally as is all 4 Ground B pins. Each power pin allows for an additional 13 amps of output power. The user must determine how many connections are necessary by calculating the required maximum current. One Ground B MUST be connected for each power pin.



The connection between CAN1 & CAN2 for the power feed is not fused (protected from short circuit current). During installation, the module power wiring on CAN1 & CAN2 pin 1 should have a 10-12A fuse before the modules.



Module power should NOT be used to power any output devices.

Module Pinouts

P0: Power/Configuration Port

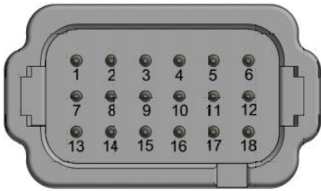

CAN Port

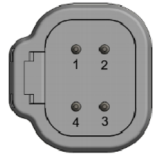

I/O Port

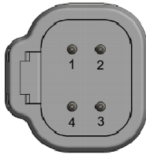

All Ground (B) connections are internally connected. All P0 connections must be made to achieve the current rating of the block.



A P0 Ground (B) connection must be made for every 13A consumed by the block.

DP-34044-1: Combo Block

Pin	P0	Pin	CAN Ports 1 & 2
1	BAUD1-A	1	POWER
2	CNFG1-A	2	CAN HIGH
3	CNFG2-A	3	GROUND A
4	CNFG3-A	4	CAN LOW
5	CNFG4-A		Output Ports 1-4
6	NC	1	GROUND B
7	BAUD1-B	2	OUTPUT B (4 Amps)
8	CNFG1-B	3	GROUND B
9	CNFG2-B	4	OUTPUT A (4 Amps)
10	CNFG3-B		Input Ports 5-8
11	CNFG4-B	1	POWER
12	GROUND B	2	INPUT B
13	BATTERY P1	3	GROUND A
14	BATTERY P2	4	INPUT A
15	NC		
16	GROUND B		
17	GROUND B		
18	GROUND B		

DP-34044-2: Input Block

Pin	P0	Pin	CAN Ports 1 & 2
1	BAUD1-A	1	POWER
2	CNFG1-A	2	CAN HIGH
3	CNFG2-A	3	GROUND A
4	CNFG3-A	4	CAN LOW
5	CNFG4-A		Input Ports 1-8
6	NC	1	POWER
7	BAUD1-B	2	INPUT B
8	CNFG1-B	3	GROUND A
9	CNFG2-B	4	INPUT A
10	CNFG3-B		
11	CNFG4-B		
12	NC		
13	NC		
14	NC		
15	NC		
16	NC		
17	NC		
18	NC		

DP-34044-3: Unpaired PWM/PWM(i) Output Block

Pin	P0	Pin	CAN Ports 1 & 2
1	BAUD1-A	1	POWER
2	CNFG1-A	2	CAN HIGH
3	CNFG2-A	3	GROUND A
4	CNFG3-A	4	CAN LOW
5	CNFG4-A		Output Ports 1, 3
6	BATTERY P4	1	GROUND B
7	BAUD1-B	2	OUTPUT B (4 Amps)
8	CNFG1-B	3	GROUND B
9	CNFG2-B	4	OUTPUT A (10 Amps)*
10	CNFG3-B		Output Ports 2, 4-8
11	CNFG4-B	1	GROUND B
12	GROUND B	2	OUTPUT B (4 Amps)
13	BATTERY P1	3	GROUND B
14	BATTERY P2	4	OUTPUT A (4 Amps)
15	BATTERY P3		
16	GROUND B		
17	GROUND B		
18	GROUND B		

DP-34044-4: Paired PWM(i) Output Block

Pin	P0	Pin	CAN Ports 1 & 2
1	BAUD1-A	1	POWER
2	CNFG1-A	2	CAN HIGH
3	CNFG2-A	3	GROUND A
4	CNFG3-A	4	CAN LOW
5	CNFG4-A		Unpaired Output Ports 1, 3
6	BATTERY P4	1	GROUND B
7	BAUD1-B	2	OUTPUT B (4 Amps)
8	CNFG1-B	3	GROUND B
9	CNFG2-B	4	OUTPUT A (10 Amps)*
10	CNFG3-B		Paired Output Ports 2, 4-8
11	CNFG4-B	1	GROUND B
12	GROUND B	2	OUTPUT B (4 Amps)
13	BATTERY P1	3	GROUND B
14	BATTERY P2	4	OUTPUT B (4 Amps)
15	BATTERY P3		
16	GROUND B		
17	GROUND B		
18	GROUND B		

DP-34044-5: Digital/Discrete Output Block

Pin	P0	Pin	CAN Ports 1 & 2
1	BAUD1-A	1	POWER
2	CNFG1-A	2	CAN HIGH
3	CNFG2-A	3	GROUND A
4	CNFG3-A	4	CAN LOW
5	CNFG4-A		Output Ports 1-8
6	BATTERY P1	1	GROUND B
7	BAUD1-B	2	OUTPUT B (4 Amps)
8	CNFG1-B	3	GROUND B
9	CNFG2-B	4	OUTPUT A (4 Amps)
10	CNFG3-B		
11	CNFG4-B		
12	GROUND B		
13	BATTERY P1		
14	BATTERY P1		
15	BATTERY P1		
16	GROUND B		
17	GROUND B		
18	GROUND B		

*Digital only, no PWM

I/O Specifications

DP-34044-1: Combo Block		
Total Number of I/O	16 (8 inputs, 8 outputs)	
Configurable Inputs	4 Digital, 4 Analog or Digital	
Digital Input Configurations	Digital Positive, Digital Ground, Frequency/Counter/Encoder	
Analog Input Configurations	0-5V DC, 0-10V DC, 0-32V DC, 4-20ma, Ratiometric	
Configurable Outputs	8 Digital, PWM, or PWM(i)	
Total Output Current	26A	
Digital Inputs Port 5: A, B Port 6: A, B Port 7: A, B Port 8: A, B	Positive Switching Ground Switching Input Resistance	>0.8 V DC <0.3 V DC Positive 10 kΩ Ground 470 kΩ
Default Configuration Positive Switching	Input Response Time	20 mSec
	Counter/Encoder: 7A, 8A	
Analog Inputs Port 5: B Port 6: B Port 7: B Port 8: B	Voltage Input Voltage Range	0...5 V DC 0...10 V DC 0...32 V DC
	Resolution	12 bit
	Input Resistance	5 V DC 166 kΩ 10 V DC 55 kΩ 32 V DC 37.6 kΩ
	Accuracy	1% Full Scale
	Input Response Time	20 mSec
	Current Input Current Range	0-20.2 mAmp
	Resolution	12 bit
	Input Resistance	162 Ω
	Accuracy	1% Full Scale
	Input Response Time	20 mSec
Ratiometric Input Voltage Range	Voltage Range	0...32 V DC
	Resolution	0.1% (0-100.0%)
	Input Resistance	32 V DC 37.6 kΩ
	Input Response Time	20 mSec
Outputs Port 1: A, B Port 2: A, B Port 3: A, B Port 4: A, B	Digital Output Output Voltage	8...32 V DC (PO Battery voltage)
	Switching Current	4 Amps
Default Configuration Digital 4 Amps	Current-Controlled Output PWM Frequency	40-1100 Hz
	PWM(i) Frequency	100-700 Hz
	Switching Current	4 Amps

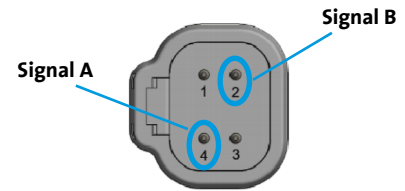

Each Load must use the return Ground (B) pin. "Chassis Grounding" is not supported.

DP-34044-2: Input Block		
Total Number of I/O	16 (all inputs)	
Digital Input Configurations	16 Digital Positive, Digital Ground, or Frequency/Counter/Encoder	
Analog Input Configurations	0-5V DC, 0-10V DC, 0-32V DC, 4-20ma, Digital Ground, Digital Positive, Ratiometric	
Total Input Current	13A	
Digital Inputs Port 1: A, B Port 2: A, B Port 3: A, B Port 4: A, B Port 5: A, B Port 6: A, B Port 7: A, B Port 8: A, B	Positive Switching Ground Switching Input Resistance	>0.8 V DC <0.3 V DC Positive 10 kΩ Ground 470 kΩ
Default Configuration Positive Switching	Input Response Time	20 mSec
	Counter/Encoder: 7A, 8A	
Analog Inputs Port 1: B Port 2: B Port 3: B Port 4: B Port 5: B Port 6: B Port 7: B Port 8: B	Voltage Input Voltage Range	0...5 V DC 0...10 V DC 0...32 V DC
	Resolution	12 bit
	Input Resistance	5 V DC 166 kΩ 10 V DC 55 kΩ 32 V DC 37.6 kΩ
	Accuracy	1% Full Scale
	Input Response Time	20 mSec
	Current Input Current Range	0-20.2 mAmp
	Resolution	12 bit
	Input Resistance	162 Ω
	Accuracy	1% Full Scale
	Input Response Time	20 mSec
Ratiometric Input Voltage Range	Voltage Range	0...32 V DC
	Resolution	0.1% (0-100.0%)
	Input Resistance	32 V DC 37.6 kΩ
	Input Response Time	20 mSec

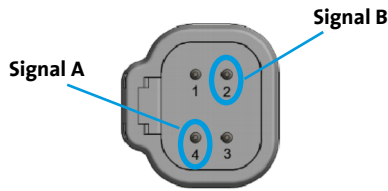

**Each Load must use the return Ground (B) pin.
“Chassis Grounding” is not supported.**

DP-34044-4: Paired PWM(i) Output Block		
Total Number of I/O	16 (all outputs)	
Output Configurations	12 Digital, PWM, PWM(i); 2 Digital up to 10 Amp (paired outputs only)	
Total Output Current	52A	
Outputs Port 1: B Port 2: A, B Port 3: B Port 4: A, B Port 5: A, B Port 6: A, B Port 7: A, B Port 8: A, B	Digital Output Output Voltage	8...32 V DC (P0 Battery voltage)
	Switching Current	4 Amps 10 Amps (Port 1A, Pin 4) 10 Amps (Port 3A, Pin 4)
Default Configuration Digital 4 Amps	<u>Current-Controlled Output</u>	
	PWM Frequency	40-1100 Hz
	PWM(i) Frequency	100-700 Hz
	Switching Current	4 Amps

DP-34044-3: PWM/Unpaired PWM(i) Output Block		
Total Number of I/O	16 (all outputs)	
Output Configurations	12 Digital, PWM, or PWM(i); 2 Digital up to 10 Amp (unpaired outputs only)	
Total Output Current	52A	
Outputs Port 1: B Port 2: A, B Port 3: B Port 4: A, B Port 5: A, B Port 6: A, B Port 7: A, B Port 8: A, B	Digital Output Output Voltage	8...32 V DC (P0 Battery voltage)
	Switching Current	4 Amps 10 Amps (Port 1A, Pin 4) 10 Amps (Port 3A, Pin 4)
Default Configuration Digital 4 Amps	<u>Current-Controlled Output</u>	
	PWM Frequency	40-1100 Hz
	PWM(i) Frequency	100-700 Hz
	Switching Current	4 Amps

DP-34044-5: Digital Output Block		
Total Number of I/O	16	
Output Configurations	16 Digital	
Switching Current	14 Outputs: 4A 2 Outputs: 10A (Port 1A, Pin 4; Port 3A, Pin 4)	
Total Output Current	52A	
Outputs Port 1: B Port 2: A, B Port 3: B Port 4: A, B Port 5: A, B Port 6: A, B Port 7: A, B Port 8: A, B	Digital Output Output Voltage	8...32 V DC (P0 Battery voltage)
	Switching Current	4 Amps 10 Amps (Port 1A, Pin 4) 10 Amps (Port 3A, Pin 4)

INPUT OPERATION

The input operation will be different depending on the configuration chosen for the input and the input pin being configured. See CAN tables for specific bit assignment. **Sensor power for each port needs to be enabled to receive 9-32V DC on Pin 1. See Control Message 1.**

Input Operation			
Function	Applicable Input Port	Mode Value	Description
Disabled	A & B	0	Putting a "0" in the mode for an input disables the input. It is recommended to disable any inputs that aren't being used.
Digital Positive On/Off	A & B	1	This puts the input into the standard digital positive operation mode. When a positive voltage is present on the input pin, the low bit will turn on.
Digital Ground On/Off	A & B	2	This puts the input into the standard digital ground operation mode. When a ground is present on the input pin, the low bit will turn on.
4-20 mA	B	3	This puts the input into 4-20 mA mode with a value of 4,000 - 20,000 = 4000 - 20,000 macro amps. See Table 1 in the Mode Operation Examples.
0...5 V DC	B	4	This puts the input into 0...5 V DC mode with a value of 0 - 5,000 = 0 - 5,000 mV. See Table 2 in the Mode Operation Examples.
0...10 V DC	B	5	This puts the input into 0-10 V DC mode with a value of 0 - 10,000 = 0 - 10,000mV. See Table 3 in the Mode Operation Examples.
0...32 V DC	B	6	This puts the input into 0...32 V DC mode with a value of 0 - 32,000 = 0 - 32,000 mV. See Table 4 in the Mode Operation Examples.
Frequency	A	7	This puts the input into frequency operation mode. When a positive signal is present on the input pin, the frequency will be shown. Only valid on 7A or 8A.
Counter	A	8	This puts the input into counter operation mode. When a positive signal is present on the input pin, the count will increase. Only valid on 7A or 8A.
Ratiometric	B	9	This puts the input into Ratiometric mode with a value of 0 - 1,000 equaling 0 - 100.0% of P0 Battery voltage. See Table 5 in the Mode Operation Examples.
Encoder	A	A	This puts the input 7A and 8A into Encoder operation mode. Both input 7A and 8A are used for the encoder input; when changing input 7A to encoder mode, it automatically sets up 8A to work with it. See Encoder Operation on page 21.

Input Status Messages		
Function	Applicable Variants	Description
Digital Input Message (DIGIN)	DP-34044-1, -2	2 bit "bit pairs" for digital inputs
Analog Inputs 1A-2B Message (AD2)	DP-34044-2	16 bit decimal data for analog readings
Analog Inputs 3A-4B Message (AD3)		
Analog Inputs 5A-6B Message (AD4)	DP-34044-1, -2	16 bit decimal data for analog readings
Analog Inputs 7A-8B Message (AD5)		
Frequency Inputs 7A-8A Message (FREQ)		

Counter Operation

xtremeDB has counter function, which allows for the control of designated outputs to work asynchronously to the controller. The output, if the enable bit is on and upon reaching its setpoint, will shut off. The output will not automatically turn on when the counter is on. The counter can be set up using configuration 0x57h. Counter data, in the form of 16-bit unsigned numbers (0-65535), is stored in Message [FREQ] PGN 65307.

Counter: Basic

Setpoint zero, Reset off, Overflow off

Turning off the counter does not reset the accumulative value of the counter. If Overflow is not selected, the counter will only accrue up to the setpoint entered or **65535**. Subsequent counts are ignored.

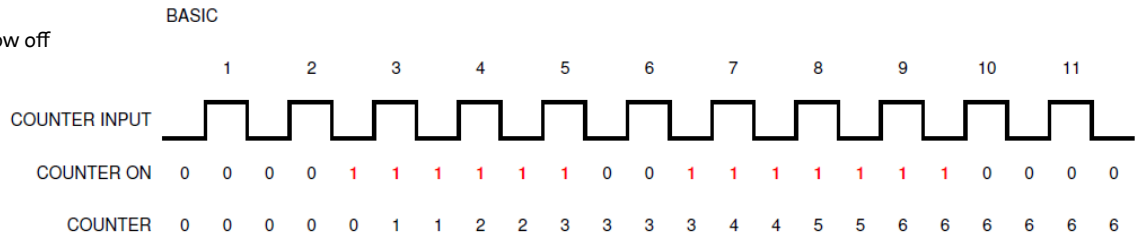

Counter: Using Reset

Setpoint zero, Overflow off

A counter reset does not clear the counter setpoint. A counter reset will clear the current count and does not turn the counter OFF.

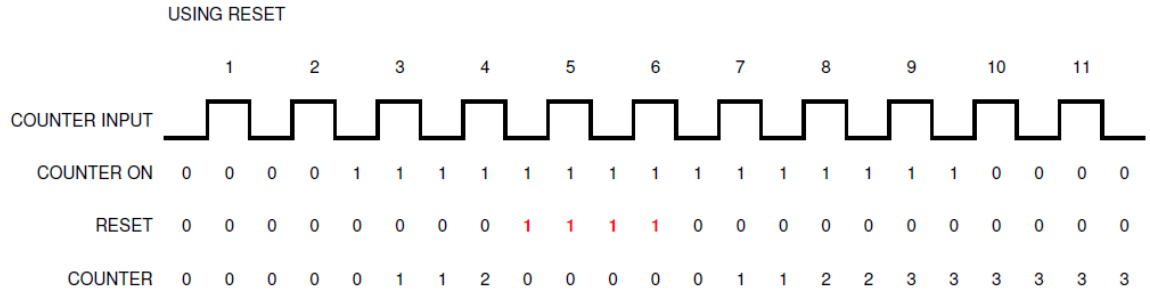

Counter: Using Setpoint

Setpoint set, Reset off, Overflow off

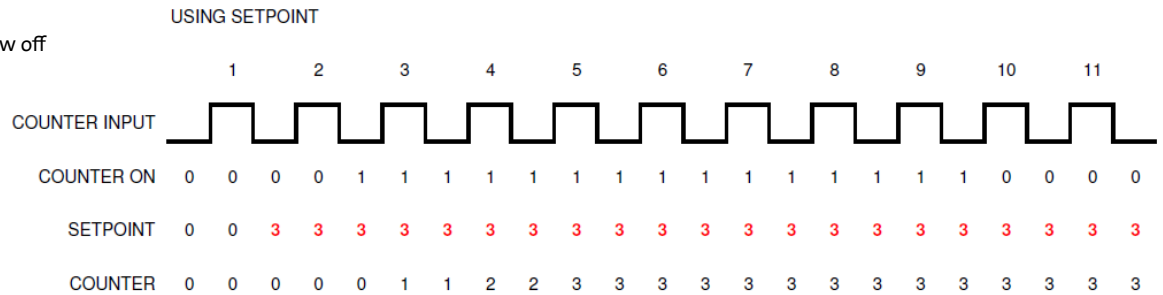

Counter: Linking Output and Overflow

Setpoint set, Reset off, Overflow on, Output Enable on

Output 3A Enable can be linked to Counter 7A. Output 4A Enable can be linked to Counter 8A. The output must be turned on by the controller in the digital control message, then the counter is turned on. The output is turned off when the setpoint is reached. A counter reset is required for the next cycle.

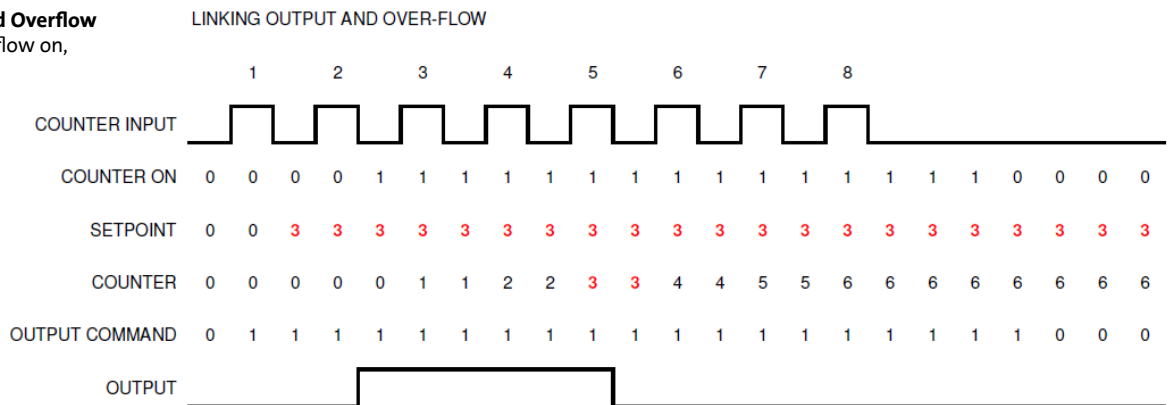

Encoder Operation

xtremeDB has an encoder function that, when the channels are correctly connected, takes care of incrementing or decrementing the count. In encoder mode, bytes 1 & 2 are the low word and bytes 3 & 4 are the high word to display a 32 bit value of the encoder count. The 32 bit signed maximum positive count is **2,147,483,647**. This mode is accessible via input ports 7A and 8A, and any compatible functions are tied to counter 7A: ON/OFF or Reset. Channel A of the encoder is connected to Input 7A and Channel B is connected to Input 8A.

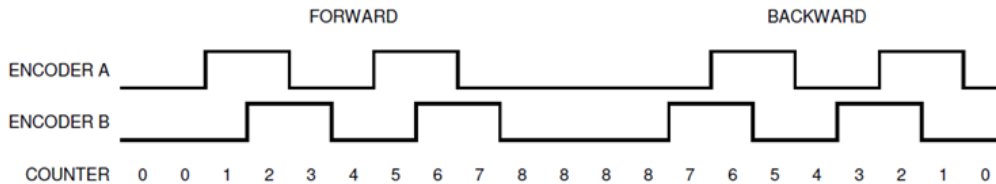

Encoder setup uses Command 0x57h. When port 7A is configured as an Encoder, Port 8A configuration is ignored. Encoder data is in Message [FREQ] PGN 65307. The xtremeDB encoder function, when the channels are correctly connected, takes care of incrementing or decrementing the count.

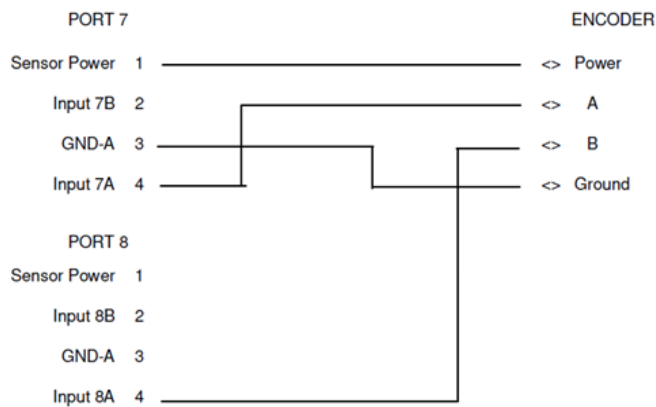

Encoder Configuration									
Data Type		Bit 8	Bit 7	Bit 6	Bit 5	Bit 4	Bit 3	Bit 2	Bit 1
Double Word	Byte 1	Least Significant Byte (LSB)							
	Byte 2								
	Byte 3								
	Byte 4	Most Significant Byte (MSB)							
Word	Byte 5	Not Used							
	Byte 6								
	Byte 7								
	Byte 8								

OUTPUT OPERATION

The output operation will be different depending on the configuration chosen for the output. **This table does not apply to any 10 Amp outputs.**

Output Operation		
Function	Mode Value	Description
Disabled	0	Putting a "0" in the mode for disables the output. It is recommended to disable any outputs that aren't being used.
Digital	1	This puts the output into on/off positive switching mode.
Data	2	This puts the output into PWM control with a value of 0 - 4000 equaling 0 - 100% of the duty cycle. Two bytes are allocated for each of the PWM control messages with the first 12 bits (Word data type) being used for the value. See Table 6 in the Mode Operation Examples.
Percent	3	This puts the output into PWM control with a value of 0 - 1000 equaling 0 - 100.0% of the duty cycle. Two bytes are allocated for each of the PWM control messages with the first 12 bits (Word data type) being used for the value. See Table 7 in the Mode Operation Examples.
Current	4	This puts the output into PWM(i) current control with a value of 0 - 4000 equaling 0 - 4000mA. Two bytes are allocated for each of the PWM(i) control messages with the first 12 bits (Word data type) being used for the value. See Table 8 in the Mode Operation Examples.

Output Control Messages		
Function	Applicable Variants	Description
PWM1 Control Message	DP-34044-1, -3, -4	Outputs 1A, 1B, 2A, and 2B: Data, Percent, or Current control
PWM2 Control Message		Outputs 3A, 3B, 4A, and 4B: Data, Percent, or Current control
PWM3 Control Message	DP-34044-3, -4	Outputs 5A, 5B, 6A, and 6B: Data, Percent, or Current control
PWM4 Control Message		Outputs 7A, 7B, 8A, and 8B: Data, Percent, or Current control

PWM(i) Operation

The PWM(i) control has more status and control commands than the standard PWM control. The module takes a setpoint for the current control and closes the loop according to the values put into the Kp and Ki. The module reports the current reading on the Amp Data status message. PWM(i) control uses the "P" and "I" components of PID where Kp and Ki are the equation constants. The derivative parameter "D" is fixed at 0. Loop Tuning* (Kp and Ki) requires an understanding of Closed Loop Control.

PWM(i) is not available in Global Configuration; selection of Global Config overrides local pin-level parameters.

* Recommended starting values: Kp = 70, Ki = 30.

STATUS MESSAGES

Status Messages			
Function	Name	Applicable Variants	Description
Module Status Message	STAT	ALL	Device configuration status
Fault Count Message	FAULT		Fault counter for listed FLT faults, non-resettable
Output Status Message	DPLF1	DP-34044-1	ON/OFF/FLT status for Output 1A – 4B and Sensor Power 5-8
		DP-34044-3, -4, -5	ON/OFF/FLT status for Output 1A – 8B
Input Power Message		DP-34044-2	ON/OFF/FLT status for Sensor Power 1-8
Device Information	DPLF2	ALL	Physical PCB configuration, battery V DC, and temperature
Current Feedback	DPLT1	DP-34044-1	Output 1A – Output 2B Feedback 0 – 4.0 Amps (0.001 A/bit)
		DP-34044-3, -5	Output 1A – Output 4B Feedback 0 – 22.0 Amps (0.1 A/bit)
		DP-34044-4	Port 1 – Port 4 Feedback 0 – 10.0 Amps (0.1 A/bit)
	DPLT2	DP-34044-1	Output 3A – Output 4B Feedback 0 – 4.0 Amps (0.001 A/bit)
		DP-34044-3, -5	Output 1A – Output 4B Feedback 0 – 22.0 Amps (0.1 A/bit)
		DP-34044-4	Port 5 – Port 8 Feedback 0 – 10.0 Amps (0.1 A/bit)

J1939 Configuration

Applicable Configurations by Variant

Configuration	Value	Command	DP-34044-1	DP-34044-2	DP-34044-3	DP-34044-4	DP-34044-5
Port	81	0x51h	X*	X	X	X	X
Global	82	0x52h	X	X	X	X	X
I/O	83	0x53h	X	X	X	X	N/A
I/O and PWM(i)	84	0x54h	X	X	X	X	N/A
PWM(i)	85	0x55h	X	N/A	X	X	N/A
PWM(i)	86	0x56h	X	N/A	X	X	N/A
Counter	87	0x57h	X	X	N/A	N/A	N/A
Output	88	0x58h	N/A	N/A	X	X	X
PWM(i)	89	0x59h	N/A	N/A	X	N/A	N/A
PWM(i)	90	0x5Ah	N/A	N/A	X	N/A	N/A
Variable Transmission Rate	91	0x5Bh	X	X	N/A	N/A	N/A

* X indicates that there is an applicable message for this variant. Click on the X to jump to the corresponding page.

Command 0x52h (This message is used to set general parameters and global configuration of I/O):

- Configure which additional status messages transmitted.
- Configure module for 24V DC operation.
- Command used to set the write configuration bit pair.
- Set the frequency of the PWM outputs.

Command 0x53h & 54h (This message needs to be sent until the message confirmation bit is set True):

- Configure individual input and output modes if they haven't been configured in Mode 1 and Mode 2 in Command 0x52h.

Command 0x54h, 55h & 56h (This message needs to be sent until the message confirmation bit is set True):

- Configure the Kp and Ki for any PWM current controls.

Command 0x57h (This message needs to be written all the time if a person is controlling the counter. A person needs to keep the counter on and needs to be able to reset the count):

- Configure the counters/encoder if using these functions.

Command 0x5Bh (This message only needs to be written if changing the transmission rates of the digital or analog input(s) messages is desired):

- Configure the transmit rates.

Status messages - Status message 1 PGN (EF(Controller Source Address)):

- Status 1 – Factory default configuration returns a value of 1, this should not be on if a module has been configured.
- Status 2 – Configuration Saved returns a value of 1 if the alternate configuration was on (value of 1) and saved the configuration using "Save Configuration" in Command 52.
- Status 3 – Alternate configuration, a new configuration was made to the module but hasn't been saved.
- Status 9-14 – Returns a value of 1 each time a Command message 52-57 is sent, to ensure each configuration has been sent. This is on for 1 second and then resets.

Command 0x51h (Outputs digital control and Input Port Sensor Power) and PWM control messages need to be consistently sent.

DP-34044-1 Configuration Process

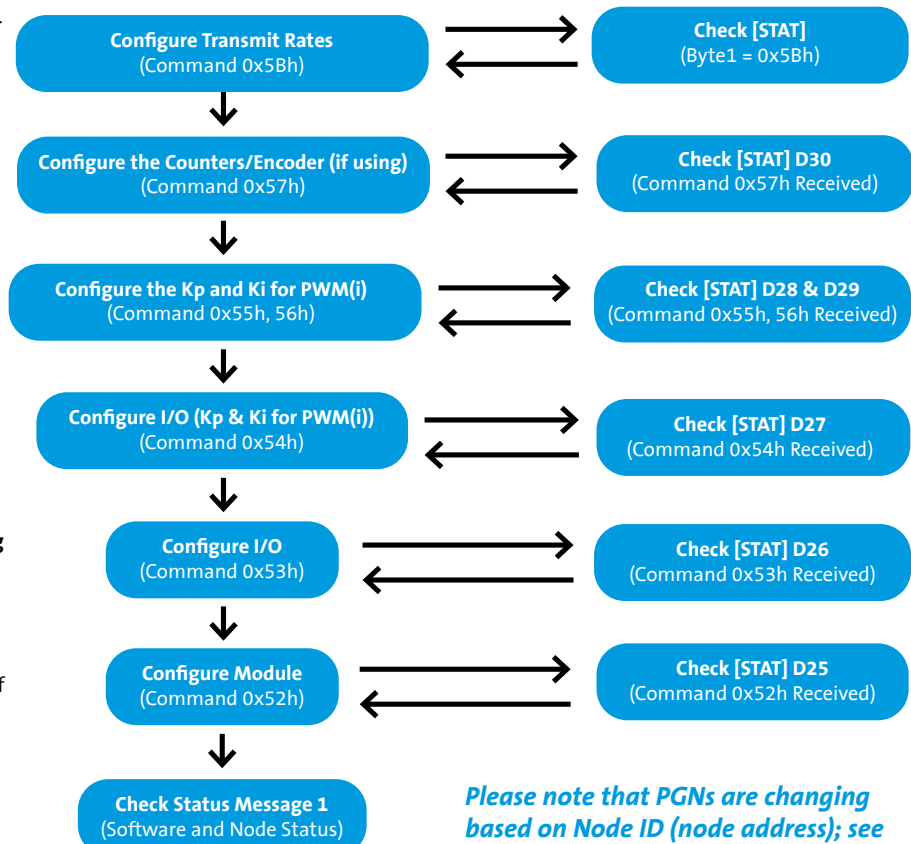

Please note that PGNs are changing based on Node ID (node address); see section "PGNs USED" for details.



Configuration messages on 0x52h-0x56h, 0x5Bh should only be sent until receipt is confirmed, DO NOT send continuously.

DP-34044-2 Configuration Process

Command 0x52h (This message is used to set general parameters and global configuration of I/O):

- Configure which additional status messages transmitted.
- Configure module for 24V DC operation.
- Command used to set the write configuration bit pair.
- Set the frequency of the PWM outputs.

Command 0x53h & 54h (This message needs to be sent until the message confirmation bit is set True):

- Configure individual input and output modes if they haven't been configured in Mode 1 and Mode 2 in Command 0x52h.

Command 0x57h (This message needs to be written all the time if a person is controlling the counter. A person needs to keep the counter on and needs to be able to reset the count):

- Configure the counters/encoder if using these functions.

Command 0x5Bh (This message only needs to be written if changing the transmission rates of the digital or analog input(s) messages is desired):

- Configure the transmit rates.

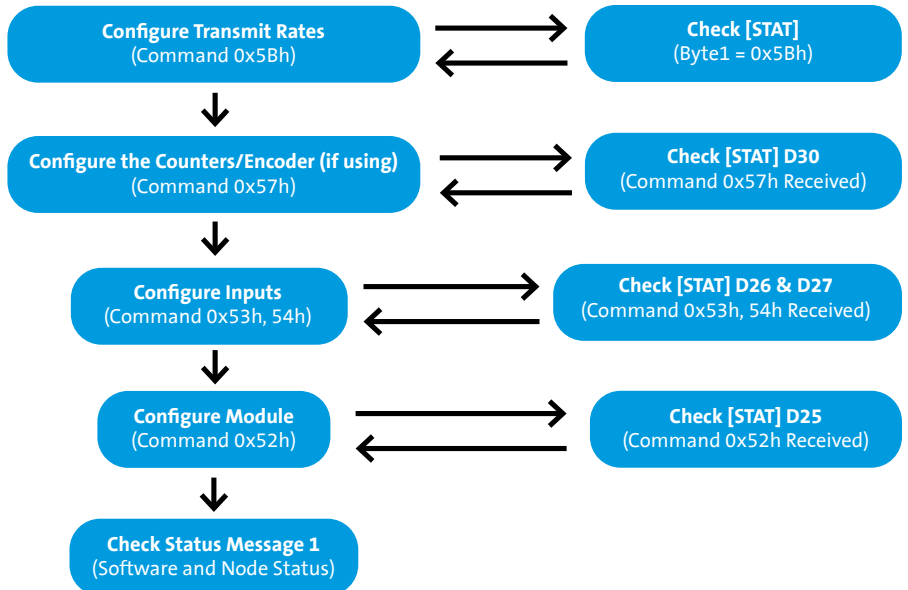

DP-34044-3 Configuration Process

Command 0x52h-57h (These messages need to be sent until the message confirmation bit is set True):

- Configure the Kp and Ki for any PWM current controls.
- Command 0x59h and 5Ah do not have a confirmation bit.

Status messages - STAT PGN (EF(Controller Source Address)):

- Status 1 – Factory default configuration returns a value of 1, this should not be on if a module has been configured.
- Status 2 – Configuration Saved returns a value of 1 if the alternate configuration was on (value of 1) and saved the configuration using “Save Configuration” in Command 52.
- Status 3 – Alternate configuration, a new configuration was made to the module but hasn't been saved.
- Status 7, 9-14 – Returns a value of 1 each time a Command message 52-58 is sent, to ensure each configuration has been sent. This is on for a brief moment and then resets.

Command 0x58h (This message is used to set the current limit on the 10 Amp outputs):

- Applies to Output 1A and Output 3A

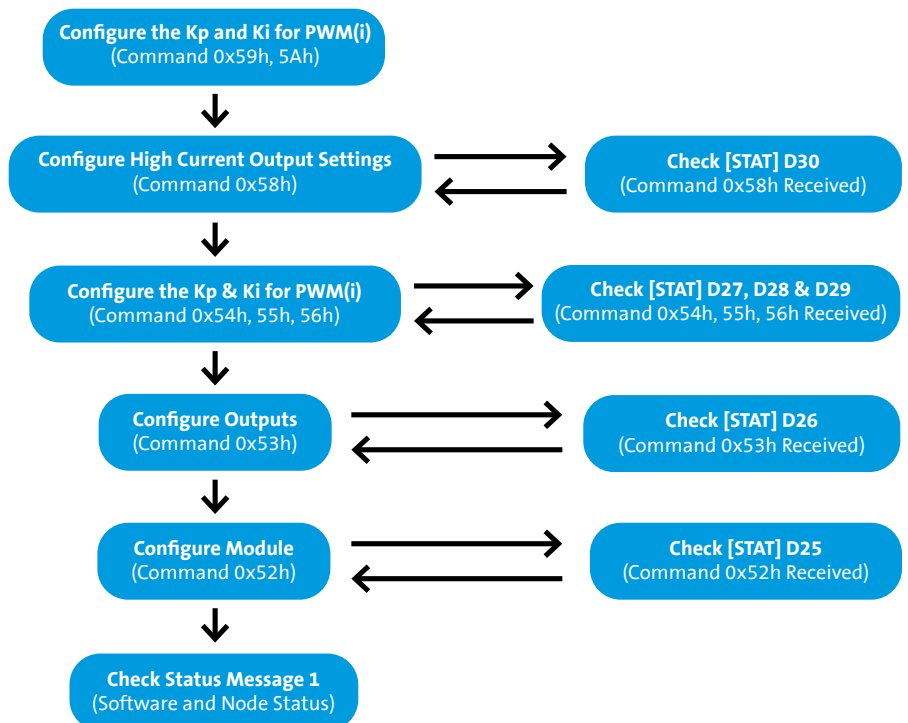

Command 0x52h (This message is used to set general parameters and global configuration of I/O):

- Configure which additional status messages transmitted.
- Configure module for 24V DC operation.
- Command used to set the write configuration bit pair.
- Set the frequency of the PWM outputs.

Status messages - Status message 1 PGN (EF(Controller Source Address)):

- Status 1 – Factory default configuration returns a value of 1, this should not be on if a module has been configured.
- Status 2 – Configuration Saved returns a value of 1 if the alternate configuration was on (value of 1) and saved the configuration using “Save Configuration” in Command 52.
- Status 3 – Alternate configuration, a new configuration was made to the module but hasn't been saved.
- Status 9-14 – Returns a value of 1 each time a Command message 52-57 is sent, to ensure each configuration has been sent. This is on for a brief moment and then resets.

Command 0x58h (This message is used to set the current limit on the 10 Amp outputs):

- Applies to Output 1A and Output 3A

DP-34044-4 Configuration Process

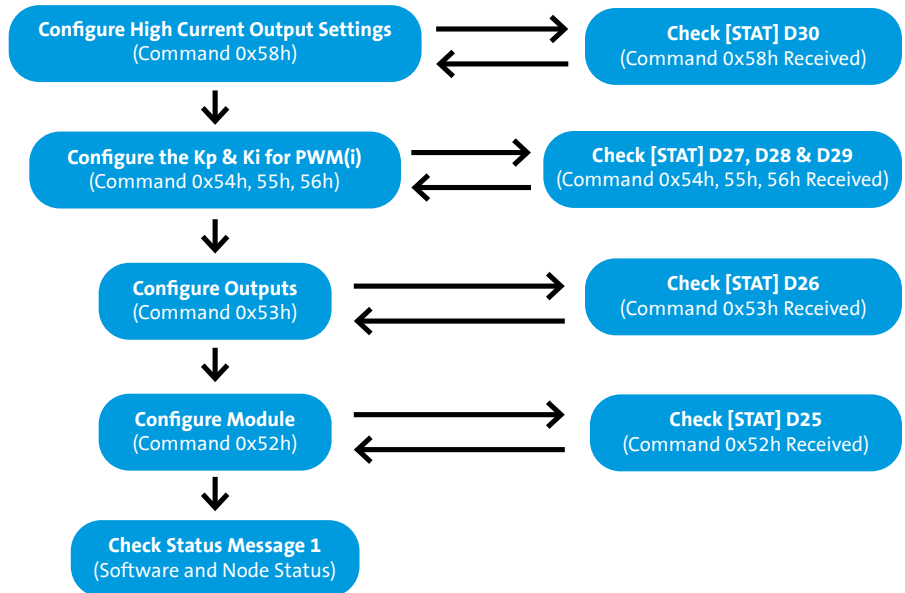

Command 0x52h (This message is used to set general parameters and global configuration of I/O):

- Configure which additional status messages transmitted.
- Configure module for 24V DC operation.
- Command used to set the write configuration bit pair.
- Set the frequency of the PWM outputs.

Command 0x58h (This message is used to set the current limit on the 10 Amp outputs):

- Applies to Output 1A and Output 3A

DP-34044-5 Configuration Process

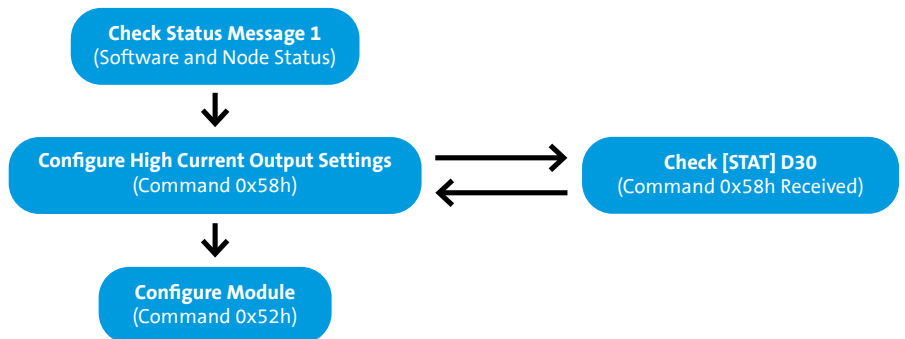

Configuration messages should only be sent until receipt is confirmed. DO NOT send continuously.

NOTES ON MODULE CONFIGURATION

PGN 61184 (0xEF00h) is the base message ID for destination-specific PGNs. This message is sent from the xtremeDB to the controller. This message will not transmit until the receipt of CTRL1 from the controller and the controller SA can be identified.

Example:

Controller is SA 92d (0x5Ch) and the module is at SA 224d (0xE0h).

The xtremeDB (CTRL1) message sent to the module is 0xEFE05Ch.

The xtremeDB [STAT] message will go out as 0xEF5CE0h.

PGN 0xEF5C (61276d)

Inputs and outputs can be configured globally or individually. Both configuration types use the same PGN. PGN 61408 is used for multiple messages by use of a different value put into the "Command" byte of the PGN. This value is used as an index or pointer as to where the information goes in the module.

All PGNs are shown as module-configured with no jumpers (Offset = 0)

- Factory Default Config returns 1 in Status message 1-Status 1, this should not be on if the module has been configured.
- Default configuration does not require a Command 0x52h message to enable operation.
- Default operation of the module is on/off digital control. PWM control messages are not needed.
- Default operation of the module is digital positive inputs.

Proprietary A Response Message [STAT] (PGN 61184-Base)		
PGN (0xEF00 + CTRL1 SA)	Dec	Hex
Data Length	8	8
Priority: 6	24	0x18
EDP & DP	0	0
PDU Format	239	0xEF
PDU Specific	CTRL1 PGN 61408 SA	
SA - Response Base	224	0xE0
Transmission Repetition	200 mSec	
Message Timeout	Command 0x50h - 0x58h	

Control Message 1 / PGN 61408									
Data Type		Bit 8	Bit 7	Bit 6	Bit 5	Bit 4	Bit 3	Bit 2	Bit 1
Byte	Byte 1	Command							
	Byte 2	Byte 2							
	Byte 3	Byte 3							
	Byte 4	Byte 4							
	Byte 5	Byte 5							
	Byte 6	Byte 6							
	Byte 7	Byte 7							
	Byte 8	Byte 8							

NOTE: Data Panel uses little-endian bit ordering

Command	Value	Configuration	DP-34044-1	DP-34044-2	DP-34044-3	DP-34044-4	DP-34044-5
0x50h	80	Spare DPBlock Command	X	X	X	X	X
0x51h	81	Port	X*	X	X	X	X
0x52h	82	Global	X	X	X	X	X
0x53h	83	I/O	X	X	X	X	N/A
0x54h	84	I/O and PWM(i)	X	X	X	X	N/A
0x55h	85	PWM(i)	X	N/A	X	X	N/A
0x56h	86	PWM(i)	X	N/A	X	X	N/A
0x57h	87	Counter	X	X	N/A	N/A	N/A
0x58h	88	Output	N/A	N/A	X	X	X
0x59h	89	PWM(i)	N/A	N/A	X	N/A	N/A
0x5Ah	90	PWM(i)	N/A	N/A	X	N/A	N/A
0x5Bh	91	Variable Transmission Rate	X	X	N/A	N/A	N/A

* X indicates that there is an applicable message for this variant. Click on the X to jump to the corresponding page.

NOTES ON GLOBAL CONFIGURATION

Global configuration is only used if all the inputs and/or outputs should be configured the same. Global Configuration only works for digital configuration. Configuring all of the inputs is done through the "MODE2" byte in PGN 61408.

Value 81 (Command 0x51h): All Variants

Command 0x51h (Outputs digital control and Inputs power control) and PWM control messages need to be consistently sent to prevent timeout.

Port Configuration / Output Control Message 1									
Data Type		Bit 8	Bit 7	Bit 6	Bit 5	Bit 4	Bit 3	Bit 2	Bit 1
Byte	Byte 1	Command							
2 bit	Byte 2	Output 2B		Output 2A		Output 1B		Output 1A	
	Byte 3	Output 4B		Output 4A		Output 3B		Output 3A	
	Byte 4	Output 6B		Output 6A		Output 5B		Output 5A	
	Byte 5	Output 8B		Output 8A		Output 7B		Output 7A	
	Byte 6	Input Power Port 4		Input Power Port 3		Input Power Port 2		Input Power Port 1	
	Byte 7	Input Power Port 8		Input Power Port 7		Input Power Port 6		Input Power Port 5	
Byte	Byte 8	Spare							

NOTE: Data Panel uses little-endian bit ordering

Name	Applicable Variant	Description	
Command	All	Command for index pointer (0x51h)	
Output 2B	DP-34044-1, -3, -4, -5	Turns the output on when in Digital Mode (not used when using any other mode)	
Output 2A			
Output 1B			
Output 1A			
Output 4B			
Output 4A			
Output 3B			
Output 3A			
Output 6B			
Output 6A			
Output 5B			
Output 5A			
Output 8B			
Output 8A			
Output 7B			
Output 7A			
Input Power Port 4	DP-34044-2	Enable Input Power (00 = off), (01 = on)	
Input Power Port 3			
Input Power Port 2			
Input Power Port 1			
Input Power Port 8	DP-34044-1, -2		
Input Power Port 7			
Input Power Port 6			
Input Power Port 5			
Bytes 4-6	DP-34044-1		N/A
Bytes 2-5	DP-34044-2		
Byte 7	DP-34044-3, -4, -5		

PGN with SA offset and Command Value = 0x51h must be sent periodically to prevent sensor power outputs from timing out.

Value 82 (Command 0x52h): All Variants

Global Configuration									
Data Type		Bit 8	Bit 7	Bit 6	Bit 5	Bit 4	Bit 3	Bit 2	Bit 1
Byte	Byte 1	Command							
2 bit	Byte 2	Enable Amp Message		Enable Status 2 Message		Enable Status 1 Message		Control Mode Reset	
	Byte 3	Spare		Analog Raw Value		Save Configuration		Enable 24V DC	
	Byte 4	Spare		Spare		Spare		Spare	
Word	Byte 5	Low Byte FREQ1							
	Byte 6	High Byte FREQ1							
4 bit	Byte 7	MODE2				MODE1			
Byte	Byte 8	ID1							

NOTE: Data Panel uses little-endian bit ordering

Name	Applicable Variant	Description
Command	ALL	Command for index pointer (0x52h)
Enable Amp Message		Enables the constant transmission of amperage messages
Enable Status 2 Message		Enables the constant transmission of status message 2
Enable Status 1 Message		Enables the constant transmission of status message 1
Control Mode Reset		Enables Controller Mode Output Reset
Analog Raw Value	DP-34044-1, -2, -3, -4	Sets all analog to be read in raw value as opposed to scaled (.005668/bit)
	DP-34044-5	N/A
Save Configuration	ALL	Saves the configuration to the module (otherwise changes only valid until a power cycle occurs), set to 1 to write configuration to module
Enable 24V DC	DP-34044-1, -2, -5	Enables the low and over voltage fault limits for 24V DC system, otherwise feeding 24V DC to 12V DC system would cause system over voltage error. This is also used for the output overcurrent and short circuit detection.
	DP-34044-3, -4	Set 0x00b
Low Byte FREQ1	DP-34044-1, -3, -4	Sets the global configuration of the frequency for all channels. Value in decimal (40 - 1100 Hz). Example: 0xC8h = 200d = 200 Hz. Outputs will assume the default value if no other value is provided.
	DP-34044-2, -5	N/A
High Byte FREQ1	DP-34044-1, -3, -4	Sets the global configuration of the frequency for all channels. Value in decimal (40 - 1100 Hz). Example: 0xC8h = 200d = 200 Hz. Outputs will assume the default value if no other value is provided.
	DP-34044-2, -5	N/A
MODE2	DP-34044-1	Sets the global configuration of the inputs. Mode 0x0 =Not Used, 0x1 =Digital Positive, 0x2 =Digital Ground (Analog 3-7 cannot be used in global configuration mode)
	DP-34044-2, -5	N/A
	DP-34044-3, -4	Not used, set 0
MODE1	DP-34044-1, -3, -4	Sets the global configuration of ALL the outputs, overrides 0x53h and 0x54h. Mode 0x0 = Mode 1: Not Used, 0x1 = Digital, 0x2 = Data 0-4,000, 0x3 = Percent 0-100.0% (0-1,000), 0x4 = Current (0-4,000 mA): cannot be used in this mode
	DP-34044-2, -5	N/A
ID1	ALL	User defined byte for configuration ID, this will be transmitted in the STAT message



If “Enable 24V DC” is not enabled, feeding 24V DC into the 12V DC system will cause an overvoltage fault in the system. This parameter is also used for output overcurrent and short circuit detection.

Value 83 (Command 0x53h): DP-34044-1

I/O Configuration									
Data Type		Bit 8	Bit 7	Bit 6	Bit 5	Bit 4	Bit 3	Bit 2	Bit 1
Byte	Byte 1	Command							
4 bit	Byte 2	OUTMODE1B				OUTMODE1A			
	Byte 3	OUTMODE2B				OUTMODE2A			
	Byte 4	OUTMODE3B				OUTMODE3A			
	Byte 5	OUTMODE4B				OUTMODE4A			
	Byte 6	INMODE5B				INMODE5A			
	Byte 7	INMODE6B				INMODE6A			
	Byte 8	INMODE7B				INMODE7A			

NOTE: Data Panel uses little-endian bit ordering

Name	Description
Command	Command for index pointer (0x53h)
OUTMODE1B	Mode 0x0= Disabled, 0x1= Digital, 0x2= Data (0-4,000), 0x3= Percent (0-1,000 = 0-100.0%), 0x4= Current (0-4,000 = 0-4.000A)
OUTMODE1A	
OUTMODE2B	
OUTMODE2A	
OUTMODE3B	
OUTMODE3A	
OUTMODE4B	
OUTMODE4A	
INMODE5B	Mode 0x0= Disabled, 0x1= Digital Positive, 0x2= Digital Ground, 0x3= 4-20mA (4,000-20,000), 0x4= 0-5V DC (0-5,000), 0x5= 0-10V DC (0-10,000), 0x6= 0-32V DC (0-32,000), 0x9= Ratiometric (0-100.0% of P0 V DC)
INMODE6B	
INMODE7B	
INMODE5A	Mode 0x0= Disabled, 0x1= Digital Positive, 0x2= Digital Ground
INMODE6A	
INMODE7A	Mode 0x0= Disabled, 0x1= Digital Positive, 0x2= Digital Ground, 0x7= Frequency, 0x8= Counter, 0xA= Encoder

Value 83 (Command 0x53h): DP-34044-2

Input Configuration									
Data Type		Bit 8	Bit 7	Bit 6	Bit 5	Bit 4	Bit 3	Bit 2	Bit 1
Byte	Byte 1	Command							
4 bit	Byte 2	INMODE1B				INMODE1A			
	Byte 3	INMODE2B				INMODE2A			
	Byte 4	INMODE3B				INMODE3A			
	Byte 5	INMODE4B				INMODE4A			
	Byte 6	INMODE5B				INMODE5A			
	Byte 7	INMODE6B				INMODE6A			
	Byte 8	INMODE7B				INMODE7A			

NOTE: Data Panel uses little-endian bit ordering

Name	Description
Command	Command for index pointer (0x53h)
INMODE1B	<p>Mode 0x0= Disabled, 0x1= Digital Positive, 0x2= Digital Ground, 0x3= 4-20mA (4,000-20,000), 0x4= 0-5V DC (0-5,000), 0x5= 0-10V DC (0-10,000), 0x6= 0-32V DC (0-32,000), 0x9= Ratiometric (0-100.0% of P0 V DC)</p>
INMODE2B	
INMODE3B	
INMODE4B	
INMODE5B	
INMODE6B	
INMODE7B	
INMODE1A	<p>Mode 0x0= Disabled, 0x1= Digital Positive, 0x2= Digital Ground</p>
INMODE2A	
INMODE3A	
INMODE4A	
INMODE5A	
INMODE6A	
INMODE7A	<p>Mode 0x0=Disabled, 0x1=Digital Positive, 0x2=Digital Ground, 0x7= Frequency, 0x8=Counter, 0xA=Encoder</p>

Value 83 (Command 0x53h): DP-34044-3

Output Configuration									
Data Type		Bit 8	Bit 7	Bit 6	Bit 5	Bit 4	Bit 3	Bit 2	Bit 1
Byte	Byte 1	Command							
4 bit	Byte 2	OUTMODE1B				OUTMODE1A			
	Byte 3	OUTMODE2B				OUTMODE2A			
	Byte 4	OUTMODE3B				OUTMODE3A			
	Byte 5	OUTMODE4B				OUTMODE4A			
	Byte 6	OUTMODE5B				OUTMODE5A			
	Byte 7	OUTMODE6B				OUTMODE6A			
	Byte 8	OUTMODE7B				OUTMODE7A			

NOTE: Data Panel uses little-endian bit ordering

Name	Description
Command	Command for index pointer (0x53h)
OUTMODE1B	N/A
OUTMODE1A	Mode 0x0= Disabled, 0x1= Digital
OUTMODE2B	Mode 0x0= Disabled, 0x1= Digital, 0x2= Data (0-4,000), 0x3= Percent (0-1,000 = 0-100.0%), 0x4= Current (0-4,000 = 0-4.000A)
OUTMODE2A	
OUTMODE3B	N/A
OUTMODE3A	Mode 0x0= Disabled, 0x1= Digital
OUTMODE4B	Mode 0x0= Disabled, 0x1= Digital, 0x2= Data (0-4,000), 0x3= Percent (0-1,000 = 0-100.0%), 0x4= Current (0-4,000 = 0-4.000A)
OUTMODE4A	
OUTMODE5B	
OUTMODE5A	
OUTMODE6B	
OUTMODE6A	
OUTMODE7B	
OUTMODE7A	

Value 83 (Command 0x53h): DP-34044-4

Output Configuration									
Data Type		Bit 8	Bit 7	Bit 6	Bit 5	Bit 4	Bit 3	Bit 2	Bit 1
Byte	Byte 1	Command							
4 bit	Byte 2	OUTMODE1B				OUTMODE1A			
	Byte 3	Spare				OUTMODE2B & OUTMODE2A			
	Byte 4					OUTMODE3B & OUTMODE3A			
	Byte 5					OUTMODE4B & OUTMODE4A			
	Byte 6					OUTMODE5B & OUTMODE5A			
	Byte 7					OUTMODE6B & OUTMODE6A			
	Byte 8					OUTMODE7B & OUTMODE7A			

NOTE: Data Panel uses little-endian bit ordering

Name	Description
Command	Command for index pointer (0x53h)
OUTMODE1B	Mode 0x0 = Disabled, 0x1 = Digital
OUTMODE1A	
OUTMODE2B & OUTMODE2A	Mode 0x0 = Disabled, 0x1 = Digital, 0x2 = Data (0-4,000), 0x3 = Percent (0-1,000 = 0-100.0%), 0x4 = Current (0-4,000 = 0-4.000A)
OUTMODE3B & OUTMODE3A	Mode 0x0 = Disabled, 0x1 = Digital
OUTMODE4B & OUTMODE4A	Mode 0x0 = Disabled, 0x1 = Digital, 0x2 = Data (0-4,000), 0x3 = Percent (0-1,000 = 0-100.0%), 0x4 = Current (0-4,000 = 0-4.000A)
OUTMODE5B & OUTMODE5A	
OUTMODE6B & OUTMODE6A	
OUTMODE7B & OUTMODE7A	

Value 84 (Command 0x54h): DP-34044-1, -2

Input and PWM(i) Configuration									
Data Type		Bit 8	Bit 7	Bit 6	Bit 5	Bit 4	Bit 3	Bit 2	Bit 1
Byte	Byte 1	Command							
4 bit	Byte 2	INMODE8B				INMODE8A			
Byte	Byte 3	Port 1A Kp							
	Byte 4	Port 1A Ki							
	Byte 5	Port 1B Kp							
	Byte 6	Port 1B Ki							
	Byte 7	Port 2A Kp							
	Byte 8	Port 2A Ki							

NOTE: Data Panel uses little-endian bit ordering

Name	Applicable Variant	Description
Command	DP-34044-1, -2	Command for index pointer (0x54h)
INMODE8B		Mode 0x0 = Disabled, 0x1 = Digital Positive, 0x2 = Digital Ground, 0x7 = Frequency, 0x8 = Counter
INMODE8A		Mode 0x0 = Disabled, 0x1 = Digital Positive, 0x2 = Digital Ground, 0x3 = 4-20mA (4,000-20,000), 0x4 = 0-5V DC (0-5,000), 0x5 = 0-10V DC (0-10,000), 0x6 = 0-32V DC (0-32,000), 0x9 = Ratiometric (0-100.0% of P0 V DC)
Port 1A Kp	DP-34044-1	Output proportional set point (0-250 = 0-2.50, >250=0) default 100
Port 1B Kp		
Port 2A Kp		
Port 1A Ki		Output integral set point (0-250 = 0-2.50, >250=0) default 100
Port 1B Ki		
Port 2A Ki		
Bytes 3-8	DP-34044-2	N/A

Value 84 (Command 0x54h): DP-34044-3

Output and PWM(i) Configuration									
Data Type		Bit 8	Bit 7	Bit 6	Bit 5	Bit 4	Bit 3	Bit 2	Bit 1
Byte	Byte 1	Command							
4 bit	Byte 2	OUTMODE8B				OUTMODE8A			
Byte	Byte 3	Spare							
	Byte 4								
	Byte 5	Port 1B Kp							
	Byte 6	Port 1B Ki							
	Byte 7	Port 2A Kp							
	Byte 8	Port 2A Ki							

NOTE: Data Panel uses little-endian bit ordering

Name	Description
Command	Command for index pointer (0x54h)
OUTMODE8B	Mode 0x0 = Disabled, 0x1 = Digital, 0x2 = Data (0-4,000), 0x3 = Percent (0-1,000 = 0-100.0%), 0x4 = Current (0-4,000 = 0-4.000A)
OUTMODE8A	
Port 1B Kp	Output proportional set point (0-250 = 0-2.50, >250=0) default 100
Port 2A Kp	
Port 1B Ki	Output integral set point (0-250 = 0-2.50, >250=0) default 100
Port 2A Ki	

Value 84 (Command 0x54h): DP-34044-4

Output and PWM(i) Configuration									
Data Type		Bit 8	Bit 7	Bit 6	Bit 5	Bit 4	Bit 3	Bit 2	Bit 1
Byte	Byte 1	Command							
4 bit	Byte 2	Spare				OUTMODE8A & OUTMODE 8B			
Byte	Byte 3	Spare							
	Byte 4								
	Byte 5	Port 2 Kp							
	Byte 6	Port 2 Ki							
	Byte 7	Spare							
	Byte 8								

NOTE: Data Panel uses little-endian bit ordering

Name	Description
Command	Command for index pointer (0x54h)
OUTMODE8B & OUTMODE8A	Mode 0x0 = Disabled, 0x1 = Digital, 0x2 = Data (0-4,000), 0x3 = Percent (0-1,000 = 0-100.0%), 0x4 = Current (0-4,000 = 0-4.000A)
Port 2 Kp	Output proportional set point (0-250 = 0-2.50, >250=0) default 100
Port 2 Ki	Output integral set point (0-250 = 0-2.50, >250=0) default 100

Value 85 (Command 0x55h): DP-34044-1, -3

PWM(i) Configuration									
Data Type		Bit 8	Bit 7	Bit 6	Bit 5	Bit 4	Bit 3	Bit 2	Bit 1
Byte	Byte 1	Command							
	Byte 2	Port 2B Kp							
	Byte 3	Port 2B Ki							
	Byte 4	Port 3A Kp							
	Byte 5	Port 3A Ki							
	Byte 6	Port 3B Kp							
	Byte 7	Port 3B Ki							
	Byte 8	Spare							

NOTE: Data Panel uses little-endian bit ordering

Name	Applicable Variants	Description
Command	DP-34044-1, -3	Command for index pointer (0x55h)
Port 2B Kp		Output proportional set point (0-250 = 0-2.50, >250=0) default 100
Port 3A Kp	DP-34044-1	
Port 3B Kp	DP-34044-1, -3	
Port 2B Ki		
Port 3A Ki	DP-34044-1	Output integral set point (0-250 = 0-2.50, >250=0) default 100
Port 3B Ki	DP-34044-1, -3	
Byte 8		

Value 85 (Command 0x55h): DP-34044-4

PWM(i) Configuration									
Data Type		Bit 8	Bit 7	Bit 6	Bit 5	Bit 4	Bit 3	Bit 2	Bit 1
Byte	Byte 1	Command							
	Byte 2	Port 4 Kp							
	Byte 3	Port 4 Ki							
	Byte 4	Port 5 Kp							
	Byte 5	Port 5 Ki							
	Byte 6	Port 6 Kp							
	Byte 7	Port 6 Ki							
	Byte 8	Spare							

NOTE: Data Panel uses little-endian bit ordering

Name	Description
Command	Command for index pointer (0x55h)
Port 4 Kp	Output proportional set point (0-250 = 0-2.50, >250=0) default 100
Port 5 Kp	
Port 6 Kp	
Port 4 Ki	Output integral set point (0-250 = 0-2.50, >250=0) default 100
Port 5 Ki	
Port 6 Ki	

Value 86 (Command 0x56h): DP-34044-1, -3

PWM(i) Configuration									
Data Type		Bit 8	Bit 7	Bit 6	Bit 5	Bit 4	Bit 3	Bit 2	Bit 1
Byte	Byte 1	Command							
	Byte 2	Port 4A Kp							
	Byte 3	Port 4A Ki							
	Byte 4	Port 4B Kp							
	Byte 5	Port 4B Ki							
	Byte 6	Port 5A Kp							
	Byte 7	Port 5A Ki							
	Byte 8	Port 5B Kp							

NOTE: Data Panel uses little-endian bit ordering

Name	Applicable Variants	Description
Command	DP-34044-1, -3	Command for index pointer (0x56h)
Port 4A Kp		Output proportional set point (0-250 = 0-2.50, >250=0) default 100
Port 4B Kp		
Port 5A Kp		
Port 5B Kp	DP-34044-3	
Port 4A Ki	DP-34044-1, -3	Output integral set point (0-250 = 0-2.50, >250=0) default 100
Port 4B Ki		
Port 5A Ki		
Bytes 6-7	DP-34044-1	N/A

Value 86 (Command 0x56h): DP-34044-4

PWM(i) Configuration									
Data Type		Bit 8	Bit 7	Bit 6	Bit 5	Bit 4	Bit 3	Bit 2	Bit 1
Byte	Byte 1	Command							
	Byte 2	Port 7 Kp							
	Byte 3	Port 7 Ki							
	Byte 4	Port 8 Kp							
	Byte 5	Port 8 Ki							
	Byte 6	Spare							
	Byte 7								
	Byte 8								

NOTE: Data Panel uses little-endian bit ordering

Name	Description
Command	Command for index pointer (0x56h)
Port 7 Kp	Output proportional set point (0-250 = 0-2.50, >250=0) default 100
Port 7 Kp	
Port 7 Kp	
Port 8 Ki	Output integral set point (0-250 = 0-2.50, >250=0) default 100
Port 8 Ki	
Port 8 Ki	

Value 87 (Command 0x57h): DP-34044-1, -2

Counter Configuration									
Data Type		Bit 8	Bit 7	Bit 6	Bit 5	Bit 4	Bit 3	Bit 2	Bit 1
Byte	Byte 1	Command							
2 bit	Byte 2	Counter 7A Enable Output 3A		Counter 7A Enable Overflow		Counter 7A Reset		Counter 7A On/Off	
	Byte 3	Counter 8A Enable Output 4A		Counter 8A Enable Overflow		Counter 8A Reset		Counter 8A On/Off	
	Byte 4	Spare		Spare		Spare		Spare	
Word	Byte 5	Counter 7A Setpoint							
	Byte 6	Counter 7A Setpoint				Spare			
	Byte 7	Counter 8A Setpoint							
	Byte 8	Counter 8A Setpoint				Spare			

NOTE: Data Panel uses little-endian bit ordering

Name	Applicable Variant	Description
Command	DP-34044-1, -2	Command for index pointer (0x57h)
Counter 7A Enable Output 3A*	DP-34044-1	Enable Output 3A when Counter 7A is enabled and set point hasn't been reached, 00 = Off, 01 = On (not used in encoder mode)
	DP-34044-2	N/A
Counter 7A Enable Overflow	DP-34044-1, -2	Enable Counter 7A Overflow, count continues after setpoint is achieved, 00 = Off, 01 = On (not used in encoder mode)
Counter 7A Reset		Reset Counter 7A, 00 = Off, 01 = On (used in encoder mode)
Counter 7A On/Off		Enable Counter 7A, 00 = Off, 01 = On (used in encoder mode)
Counter 8A Enable Output 4A**	DP-34044-1	Enable Output 4A when Counter 8A is enabled and setpoint hasn't been reached, 00 = Off, 01 = On (not used in encoder mode)
	DP-34044-2	N/A
Counter 8A Enable Overflow	DP-34044-1, -2	Enable Counter 8A Overflow, count continues after setpoint is achieved, 00 = Off, 01 = On (not used in encoder mode)
Counter 8A Reset		Reset Counter 8A, 00 = Off, 01 = On (used in encoder mode)
Counter 8A On/Off		Enable Counter 8A, 00 = Off, 01 = On (used in encoder mode)
Counter 7A Set Point*		Total count to trigger the disabling of the output (3A or 4A) and stop counting unless overflow is enabled. If overflow is enabled, the counters will keep incrementing.
Counter 8A Set Point**		

*Set a value of 1 to "Counter 7A Enable Out 3A" provides an Enable function for Output 3A. Output 3A is disabled when counter > = Set Point.

**Set a value of 1 to "Counter 8A Enable Out 4A" provides an Enable function for Output 4A. Output 4A is disabled when counter > = Set Point.

Value 88 (Command 0x58h): DP-34044-3, -4, -5

Output Configuration									
Data Type		Bit 8	Bit 7	Bit 6	Bit 5	Bit 4	Bit 3	Bit 2	Bit 1
Byte	Byte 1	Command							
	Byte 2	Port 1 Output 1A (0-100)							
	Byte 3	Port 1 Output 1B (Not Used)							
	Byte 4	Port 2 Output 2A (0-100)							
	Byte 5	Port 2 Output 2B (Not Used)							
	Byte 6	Port 3 Output 3A (0-100)							
	Byte 7	Port 3 Output 3B (Not Used)							
	Byte 8	Spare							

NOTE: Data Panel uses little-endian bit ordering

Name	Applicable Variant	Description
Command	DP-34044-3, -4, -5	Command for index pointer (0x58h)
Port 1 Output 1A (0-100)		Set amp range 0.0-10.0A = Data Range 0-100
Port 1 Output 2A (0-100)		
Port 1 Output 3A (0-100)		

Value 89 (Command 0x59h): DP-34044-3

PWM(i) Configuration									
Data Type		Bit 8	Bit 7	Bit 6	Bit 5	Bit 4	Bit 3	Bit 2	Bit 1
Byte	Byte 1	Command							
	Byte 2	Port 5B Ki							
	Byte 3	Port 6A Kp							
	Byte 4	Port 6A Ki							
	Byte 5	Port 6B Kp							
	Byte 6	Port 6B Ki							
	Byte 7	Port 7A Kp							
	Byte 8	Port 7A Ki							

NOTE: Data Panel uses little-endian bit ordering

Name	Description
Command	Command for index pointer (0x59h)
Port 5B Ki	Output integral set point (0-250 = 0-2.50, >250=0) default 100
Port 6A Ki	
Port 6B Ki	
Port 7A Ki	
Port 6A Kp	Output proportional set point (0-250 = 0-2.50, >250=0) default 100
Port 6B Kp	
Port 7A Kp	

Value 90 (Command 0x5Ah): DP-34044-3

PWM(i) Configuration									
Data Type		Bit 8	Bit 7	Bit 6	Bit 5	Bit 4	Bit 3	Bit 2	Bit 1
Byte	Byte 1	Command							
	Byte 2	Port 7B Kp							
	Byte 3	Port 7B Ki							
	Byte 4	Port 8A Kp							
	Byte 5	Port 8A Ki							
	Byte 6	Port 8B Kp							
	Byte 7	Port 8B Ki							
	Byte 8	Spare							

NOTE: Data Panel uses little-endian bit ordering

Name	Description
Command	Command for index pointer (0x5Ah)
Port 7B Kp	Output proportional set point (0-250 = 0-2.50, >250=0) default 100
Port 8A Kp	
Port 8B Kp	
Port 7B Ki	Output integral set point (0-250 = 0-2.50, >250=0) default 100
Port 8A Ki	
Port 8B Ki	

Value 91 (Command 0x5Bh): DP-34044-1, -2

Use this command only if you want the change the default transmission rates of the messages as listed. Caution should be used to manage bus load and confirm operation. This message is also the [Status Message 1 \(Response to Command 0x5Bh\) with a PGN of 61184 \(0xEF\(CSA\)\)](#).

Variable Transmission Rate Configuration									
Data Type		Bit 8	Bit 7	Bit 6	Bit 5	Bit 4	Bit 3	Bit 2	Bit 1
Byte	Byte 1	Command							
	Byte 2	DIGIN							
	Byte 3	AD2							
	Byte 4	AD3							
	Byte 5	AD4							
	Byte 6	AD5							
	Byte 7	Spare							
	Byte 8								

NOTE: Data Panel uses little-endian bit ordering

Name	Description
Command	Command for index pointer (0x5Bh)
DIGIN	Message [DIGIN] Transmit Cycle Time
AD2	Message [AD2] – Reserved. Set to 0x00h.
AD3	Message [AD3] – Reserved. Set to 0x00h.
AD4	Message [AD4] Transmit Cycle Time
AD5	Message [AD5] Transmit Cycle Time
Bytes 7 & 8	Set to 0x00h

Resolution	10 mSec/Bit
Offset	0
Data Range	10 mSec – 2500 mSec [1 – 250]
Example	180 = 1800 mSec or 1.8 seconds

PGNs USED

Depending on the selected Node SA, the PGNs and source address will be different for the module. The section below shows which are used for each Node SA.

Source Address and SA-Specific Values

Source Address	224	225	226	227	228	229	230	231	232	233	234	235	236	237	238
SA	E0	E1	E2	E3	E4	E5	E6	E7	E8	E9	EA	EB	EC	ED	EE
Control	EFE0	EFE1	EFE2	EFE3	EFE4	EFE5	EFE6	EFE7	EFE8	EFE9	EFEA	EFEB	EFEC	EFED	EFEE
PWM1	FF1C	FF20	FF24	FF28	FF2C	FF30	FF34	FF38	FF3C	FF40	FF44	FF48	FF4C	FF50	FF54
PWM2	FF1D	FF21	FF25	FF29	FF2D	FF31	FF35	FF39	FF3D	FF41	FF45	FF49	FF4D	FF51	FF55
PWM3	FF1E	FF22	FF26	FF2A	FF2E	FF32	FF36	FF3A	FF3E	FF42	FF46	FF4A	FF4E	FF52	FF56
PWM4	FF1F	FF23	FF27	FF2B	FF2F	FF33	FF37	FF3B	FF3F	FF43	FF47	FF4B	FF4F	FF53	FF57

NOTE: Reference provided SA values in the table above when building the PGN messages in the table below

	PGN Value	Default Transmit Rate	Priority	DP-34044-1	DP-34044-2	DP-34044-3	DP-34044-4	DP-34044-5
Control	61408	50 mSec	-	X*	X	X	X	X
Module Status	61184	50 mSec	6	(EF(CSA**))	(EF(CSA))	(EF(CSA))	(EF(CSA))	(EF(CSA))
Fault Count	65510	200 mSec	6	FFE6***	FFE6	FFE6	FFE6	FFE6
Output Status	65531	50 mSec	6	FFFB	N/A	FFFB	FFFB	FFFB
Input Power Status	65531	50 mSec	6	N/A	FFFB	N/A	N/A	N/A
Device Information	65532	200 mSec	6	FFFC	FFFC	FFFC	FFFC	FFFC
Digital Input Status	65301	50 mSec	6	FF15	FF15	N/A	N/A	N/A
Analog Inputs 1A-2B	65302	50 mSec	6	N/A	FF16	N/A	N/A	N/A
Analog Inputs 3A-4B	65303	50 mSec	6	N/A	FF17	N/A	N/A	N/A
Analog Inputs 5A-6B	65304	50 mSec	6	FF18	FF18	N/A	N/A	N/A
Analog Inputs 7A-8B	65305	50 mSec	6	FF19	FF19	N/A	N/A	N/A
Freq. Inputs 7A, 8A	65307	50 mSec	6	FF1B	FF1B	N/A	N/A	N/A
PWM1	65308	50 mSec	-	X	N/A	X	X	N/A
PWM2	65309	50 mSec	-	X	N/A	X	X	N/A
PWM3	65310	50 mSec	-	N/A	N/A	X	N/A	N/A
PWM4	65311	50 mSec	-	N/A	N/A	X	N/A	N/A
Amp Data 1, 3	65533	200 mSec	6	N/A	N/A	N/A	FFFD	N/A
Amp Data 1-4	65523	200 mSec	6	FFF3	N/A	N/A	N/A	N/A
Amp Data 2, 4				N/A	N/A	N/A	FFF3	N/A
Amp Data 1-8				N/A	N/A	FFF3	N/A	FFF3
Amp Data 5-8	65524	200 mSec	6	FFF4	N/A	N/A	FFF4	N/A
Amp Data 9-16				N/A	N/A	FFF4	N/A	FFF4

*See Source Address and SA-Specific Values table above

**CSA: Controller Source Address

*** Click on the X or FFXX to jump to the corresponding page.

PGN 61184 (0xEF(CSA)): All Variants

Module Status Message (STAT Proprietary A Default Response Message)										
Data Type		Bit 8	Bit 7	Bit 6	Bit 5	Bit 4	Bit 3	Bit 2	Bit 1	
Byte	Byte 1	Software Version								
	Byte 2	Software Revision								
2 bit	Byte 3	Status 4	Status 3		Status 2		Status 1			
	Byte 4	Status 8	Status 7		Status 6		Status 5			
Byte	Byte 5	Fault Code								
	Byte 6	User ID								
2 bit	Byte 7	Status 12	Status 11		Status 10		Status 9			
2 bit, 4 bit	Byte 8	Hardware Version				Status 14		Status 13		

NOTE: Data Panel uses little-endian bit ordering

Name	Applicable Variant	Description
Software Version	ALL	Version of the current software
Software Revision		Revision of the current software
Status 4		Node Alive
Status 3		Alternate Configuration Received
Status 2		Configuration Saved (module is configured)
Status 1		Factory Default Configuration
Status 8	DP-34044-1, -2, -4	N/A
	DP-34044-3	True when Message Command = 0x59 received
	DP-34044-5	Invalid Configuration Flag
Status 7	DP-34044-1, -2	N/A
	DP-34044-3, -4, -5	True when Message Command = 0x58 received
Status 6	ALL	Fault Count not Zero
Status 5		Node Fault Present
Fault Code		Active fault code
User ID		The User ID of the module configured in CTRL1 message
Status 12	DP-34044-1, -3, -4	True when Message Command = 0x55h received
	DP-34044-2, -5	N/A
Status 11	DP-34044-1, -2, -3, -4	True when Message Command = 0x54h received
	DP-34044-5	N/A
Status 10	DP-34044-1, -2, -3, -4	True when Message Command = 0x53h received
	DP-34044-5	N/A
Status 9	ALL	True when Message Command = 0x52h received
Status 14	DP-34044-1, -3, -4	True when Message Command = 0x57h received
	DP-34044-2, -5	N/A
Status 13	DP-34044-1, -3, -4	True when Message Command = 0x56h received
	DP-34044-2, -5	N/A
Hardware Version	ALL	Version of the current hardware

PGN 65510 (0xFFE6): All Variants

		Fault Count Message							
Data Type		Bit 8	Bit 7	Bit 6	Bit 5	Bit 4	Bit 3	Bit 2	Bit 1
Byte	Byte 1	Fault Counter F1							
	Byte 2	Fault Counter F2							
	Byte 3	Fault Counter F3							
	Byte 4	Fault Counter F4							
	Byte 5	Fault Counter F5							
	Byte 6	Fault Counter F6							
	Byte 7	Fault Counter F7							
	Byte 8	Fault Counter F8							

NOTE: Data Panel uses little-endian bit ordering

PGN 65531 (0xFFFB): DP-34044-1

Output Status Message (DPLF1)									
Data Type		Bit 8	Bit 7	Bit 6	Bit 5	Bit 4	Bit 3	Bit 2	Bit 1
2 bit	Byte 1	Configuration Pair 4		Configuration Pair 3		Configuration Pair 2		Configuration Pair 1	
	Byte 2	Spare		Spare		Spare		Configuration Pair 5	
	Byte 3	Output Status 2B		Output Status 2A		Output Status 1B		Output Status 1A	
	Byte 4	Output Status 4B		Output Status 4A		Output Status 3B		Output Status 3A	
	Byte 5	Spare		Input Port 6		Spare		Input Port 5	
	Byte 6	Spare		Input Port 8		Spare		Input Port 7	
	Byte 7	Spare		Spare		Power Bus P2		Power Bus P1	
Byte	Byte 8	Save Configuration Counter							

NOTE: Data Panel uses little-endian bit ordering

Name	Description
Configuration Pair 4	Node ID 3's configuration jumper is applied
Configuration Pair 3	Node ID 2's configuration jumper is applied
Configuration Pair 2	Node ID 1's configuration jumper is applied
Configuration Pair 1	Baud rate configuration jumper is applied
Configuration Pair 5	Node ID 4's configuration jumper is applied
Output Status 2B	Status of output, (00 = off), (01 = on), (10 = fault)
Output Status 2A	
Output Status 1B	
Output Status 1A	
Output Status 4B	
Output Status 4A	
Output Status 3B	
Output Status 3A	
Input Port 6	
Input Port 5	
Input Port 8	Status of Power Bus, (00 = off), (01 = on), (10 = fault)
Input Port 7	
Power Bus P2	Status of Power Bus, (00 = off), (01 = on), (10 = fault)
Power Bus P1	Status of Power Bus, (00 = off), (01 = on), (10 = fault)
Save Configuration Counter	Count of how many times the configuration has been saved to the module

PGN 65531 (0xFFFB): DP-34044-2

Input Power Status Message (DPLF1)									
Data Type		Bit 8	Bit 7	Bit 6	Bit 5	Bit 4	Bit 3	Bit 2	Bit 1
2 bit	Byte 1	Configuration Pair 4		Configuration Pair 3		Configuration Pair 2		Configuration Pair 1	
	Byte 2	Spare		Spare		Spare		Configuration Pair 5	
	Byte 3	Spare		Input Power Port 2		Spare		Input Power Port 1	
	Byte 4	Spare		Input Power Port 4		Spare		Input Power Port 3	
	Byte 5	Spare		Input Power Port 6		Spare		Input Power Port 5	
	Byte 6	Spare		Input Power Port 8		Spare		Input Power Port 7	
	Byte 7	Spare		Spare		Spare		Spare	
Byte	Byte 8	Save Configuration Counter							

NOTE: Data Panel uses little-endian bit ordering

Name	Description
Configuration Pair 4	Node ID 3's configuration jumper is applied
Configuration Pair 3	Node ID 2's configuration jumper is applied
Configuration Pair 2	Node ID 1's configuration jumper is applied
Configuration Pair 1	Baud rate configuration jumper is applied
Configuration Pair 5	Node ID 4's configuration jumper is applied
Input Power Port 2	Status of Input Power, (00 = off), (01 = on), (10 = fault)
Input Power Port 1	
Input Power Port 4	
Input Power Port 3	
Input Power Port 6	
Input Power Port 5	
Input Power Port 8	
Input Power Port 7	
Save Configuration Counter	Count of how many times the configuration has been saved to the module

PGN 65531 (0xFFFB): DP-34044-3, -4, -5

Output Status Message (DPLF1)									
Data Type		Bit 8	Bit 7	Bit 6	Bit 5	Bit 4	Bit 3	Bit 2	Bit 1
2 bit	Byte 1	Configuration Pair 4		Configuration Pair 3		Configuration Pair 2		Configuration Pair 1	
	Byte 2	Spare		Spare		Spare		Configuration Pair 5	
	Byte 3	Output Status 2B		Output Status 2A		Output Status 1B		Output Status 1A	
	Byte 4	Output Status 4B		Output Status 4A		Output Status 3B		Output Status 3A	
	Byte 5	Output Status 6B		Output Status 6A		Output Status 5B		Output Status 5A	
	Byte 6	Output Status 8B		Output Status 8A		Output Status 7B		Output Status 7A	
	Byte 7	Power Bus P4		Power Bus P3		Power Bus P2		Power Bus P1	
Byte	Byte 8	Save Configuration Counter							

NOTE: Data Panel uses little-endian bit ordering

Name	Applicable Variant	Description
Configuration Pair 4	DP-34044-3, -4, -5	Node ID 3's configuration jumper is applied
Configuration Pair 3		Node ID 2's configuration jumper is applied
Configuration Pair 2		Node ID 1's configuration jumper is applied
Configuration Pair 1		Baud rate configuration jumper is applied
Configuration Pair 5		Node ID 4's configuration jumper is applied
Output Status 2B		Status of output, (00 = off), (01 = on), (10 = fault)
Output Status 2A		
Output Status 1B		
Output Status 1A		
Output Status 4B		
Output Status 4A		
Output Status 3B		
Output Status 3A		
Output Status 6B		
Output Status 6A		
Output Status 5B		
Output Status 5A		
Output Status 8B		
Output Status 8A		
Output Status 7B		
Output Status 7A		
Power Bus P4	DP-34044-3, -4	Status of Power Bus, (00 = off), (01 = on), (10 = fault)
	DP-34044-5	N/A
Power Bus P3	DP-34044-3, -4	Status of Power Bus, (00 = off), (01 = on), (10 = fault)
	DP-34044-5	N/A
Power Bus P2	DP-34044-3, -4	Status of Power Bus, (00 = off), (01 = on), (10 = fault)
	DP-34044-5	N/A
Power Bus P1		Status of Power Bus, (00 = off), (01 = on), (10 = fault)
Save Configuration Counter	DP-34044-3, -4, -5	Count of how many times the configuration has been saved to the module

PGN 65532 (0xFFFC): All Variants

Device Information (DPLF2)									
Data Type		Bit 8	Bit 7	Bit 6	Bit 5	Bit 4	Bit 3	Bit 2	Bit 1
Byte	Byte 1	CNFG1							
	Byte 2	CNFG2							
10 bit	Byte 3	VBAT							
	Byte 4	Spare						VBAT	
Word	Byte 5	TEMP							
	Byte 6	Spare				TEMP			
Byte	Byte 7	CNFG3							
	Byte 8	Spare							

NOTE: Data Panel uses little-endian bit ordering

Name	Applicable Variant	Description
CNFG1	ALL	Hardware Configuration
CNFG2		PCB Assembly Revision
VBAT		Battery Voltage 100mV/bit, data range 0 - 320 (32.0V DC max).
TEMP		Module Temperature , -100.0°F to +300.0°F, data range 0 – 4000 bits.
CNFG3		Additional Configuration

PGN 65301 (0xFF15): DP-34044-1, -2

Digital Input Status Message (DIGIN)									
Data Type		Bit 8	Bit 7	Bit 6	Bit 5	Bit 4	Bit 3	Bit 2	Bit 1
2 bit	Byte 1	Input 2B		Input 2A		Input 1B		Input 1A	
	Byte 2	Input 4B		Input 4A		Input 3B		Input 3A	
	Byte 3	Input 6B		Input 6A		Input 5B		Input 5A	
	Byte 4	Input 8B		Input 8A		Input 7B		Input 7A	
Byte	Byte 5	Spare							
	Byte 6								
	Byte 7								
	Byte 8								

NOTE: Data Panel uses little-endian bit ordering

Name	Applicable Variants	Description
Input 2B	DP-34044-2	00 = Off, 01 = On, 10 = Fault
Input 2A		
Input 1B		
Input 1A		
Input 4B		
Input 4A		
Input 3B		
Input 3A		
Input 6B	DP-34044-1, -2	
Input 6A		
Input 5B		
Input 5A		
Input 8B		
Input 8A		
Input 7B		
Input 7A		
Bytes 1 & 2	DP-34044-1	N/A

PGN 65302 (0xFF16): DP-34044-2

Analog Inputs 1A-2B Status Message (AD2)									
Data Type		Bit 8	Bit 7	Bit 6	Bit 5	Bit 4	Bit 3	Bit 2	Bit 1
Word	Byte 1	Analog Input 1A							
	Byte 2	Spare				Analog Input 1A			
	Byte 3	Analog Input 1B							
	Byte 4	Spare				Analog Input 1B			
	Byte 5	Analog Input 2A							
	Byte 6	Spare				Analog Input 2A			
	Byte 7	Analog Input 2B							
	Byte 8	Spare				Analog Input 2B			

NOTE: Data Panel uses little-endian bit ordering

Name	Description
Analog Input 1A	Not used on this module, discrete only
Analog Input 2A	
Analog Input 1B	Mode 0x3 = 4-20mA (4,000-20,000), 0x4 = 0-5V DC (0-5,000), 0x5 = 0-10V DC (0-10,000), 0x6 = 0-32V DC (0-32,000), 0x9 = Ratio-metric (0-100.0% of P0 V DC)
Analog Input 2B	

PGN 65303 (0xFF17): DP-34044-2

Analog Inputs 3A-4B Status Message (AD3)									
Data Type		Bit 8	Bit 7	Bit 6	Bit 5	Bit 4	Bit 3	Bit 2	Bit 1
Word	Byte 1	Analog Input 3A							
	Byte 2	Spare				Analog Input 3A			
	Byte 3	Analog Input 3B							
	Byte 4	Spare				Analog Input 3B			
	Byte 5	Analog Input 4A							
	Byte 6	Spare				Analog Input 4A			
	Byte 7	Analog Input 4B							
	Byte 8	Spare				Analog Input 4B			

NOTE: Data Panel uses little-endian bit ordering

Name	Description
Analog Input 3A	Not used on this module, discrete only
Analog Input 4A	
Analog Input 3B	Mode 0x3 = 4-20mA (4,000-20,000), 0x4 = 0-5V DC (0-5,000), 0x5 = 0-10V DC (0-10,000), 0x6 = 0-32V DC (0-32,000), 0x9 = Ratio-metric (0-100.0% of P0 V DC)
Analog Input 4B	

PGN 65304 (0xFF18): DP-34044-1, -2

Analog Inputs 5A-6B Status Message (AD4)									
Data Type		Bit 8	Bit 7	Bit 6	Bit 5	Bit 4	Bit 3	Bit 2	Bit 1
Word	Byte 1	Analog Input 5A							
	Byte 2	Spare				Analog Input 5A			
	Byte 3	Analog Input 5B							
	Byte 4	Spare				Analog Input 5B			
	Byte 5	Analog Input 6A							
	Byte 6	Spare				Analog Input 6A			
	Byte 7	Analog Input 6B							
	Byte 8	Spare				Analog Input 6B			

NOTE: Data Panel uses little-endian bit ordering

Name	Description
Analog Input 5A	Not used on this module, discrete only
Analog Input 6A	
Analog Input 5B	Mode 0x3 = 4-20mA (4,000-20,000), 0x4 = 0-5V DC (0-5,000), 0x5 = 0-10V DC (0-10,000), 0x6 = 0-32V DC (0-32,000), 0x9 = Ratio-metric (0-100.0% of P0 V DC)
Analog Input 6B	

PGN 65305 (0xFF19): DP-34044-1, -2

Analog Inputs 7A-8B Status Message (AD5)									
Data Type		Bit 8	Bit 7	Bit 6	Bit 5	Bit 4	Bit 3	Bit 2	Bit 1
Word	Byte 1	Analog Input 7A							
	Byte 2	Spare				Analog Input 7A			
	Byte 3	Analog Input 7B							
	Byte 4	Spare				Analog Input 7B			
	Byte 5	Analog Input 8A							
	Byte 6	Spare				Analog Input 8A			
	Byte 7	Analog Input 8B							
	Byte 8	Spare				Analog Input 8B			

NOTE: Data Panel uses little-endian bit ordering

Name	Description
Analog Input 7A	Not used on this module, discrete only
Analog Input 8A	
Analog Input 7B	Mode 0x3 = 4-20mA (4,000-20,000), 0x4 = 0-5V DC (0-5,000), 0x5 = 0-10V DC (0-10,000), 0x6 = 0-32V DC (0-32,000), 0x9 = Ratio-metric (0-100.0% of P0 V DC)
Analog Input 8B	

PGN 65307 (0xFF1B): DP-34044-1, -2

Frequency Inputs 7A-8A Status Message (FREQ)									
Data Type		Bit 8	Bit 7	Bit 6	Bit 5	Bit 4	Bit 3	Bit 2	Bit 1
Word	Byte 1	Hertz_Count Input 7A							
	Byte 2	Spare				Hertz_Count Input 7A			
	Byte 3	Duty Cycle_SP Input 7A							
	Byte 4	Spare				Duty Cycle_SP Input 7A			
	Byte 5	Hertz_Count Input 8A							
	Byte 6	Spare				Hertz_Count Input 8A			
	Byte 7	Duty Cycle_SP Input 8A							
	Byte 8	Spare				Duty Cycle_SP Input 8A			

NOTE: Data Panel uses little-endian bit ordering

Name	Description
Hertz_Count Input 7A	Hertz is used when the input is configured as a frequency input Count is used when the input is configured as a high speed counter
Hertz_Count Input 8A	
Duty Cycle_SP Input 7A	Duty Cycle is used when the input is configured as a frequency input Setpoint is used when the input is configured as a high speed counter
Duty Cycle_SP Input 8A	

PGN 65308 (0xFF1C*): DP-34044-1, -3, -4

PWM1 Control Message									
Data Type		Bit 8	Bit 7	Bit 6	Bit 5	Bit 4	Bit 3	Bit 2	Bit 1
Word	Byte 1	Control Output 1A							
	Byte 2	Spare				Control Output 1A			
	Byte 3	Control Output 1B							
	Byte 4	Spare				Control Output 1B			
	Byte 5	Control Output 2A							
	Byte 6	Spare				Control Output 2A			
	Byte 7	Control Output 2B							
	Byte 8	Spare				Control Output 2B			

NOTE: Data Panel uses little-endian bit ordering

* See Source Address and SA-Specific Values table for offset values

PGN 65309 (0xFF1D*): DP-34044-1, -3, -4

PWM2 Control Message									
Data Type		Bit 8	Bit 7	Bit 6	Bit 5	Bit 4	Bit 3	Bit 2	Bit 1
Word	Byte 1	Control Output 3A							
	Byte 2	Spare				Control Output 3A			
	Byte 3	Control Output 3B							
	Byte 4	Spare				Control Output 3B			
	Byte 5	Control Output 4A							
	Byte 6	Spare				Control Output 4A			
	Byte 7	Control Output 4B							
	Byte 8	Spare				Control Output 4B			

NOTE: Data Panel uses little-endian bit ordering

* See Source Address and SA-Specific Values table for offset values

PGN 65310 (0xFF1E*): DP-34044-3

PWM3 Control Message									
Data Type		Bit 8	Bit 7	Bit 6	Bit 5	Bit 4	Bit 3	Bit 2	Bit 1
Word	Byte 1	Control Output 5A							
	Byte 2	Spare				Control Output 5A			
	Byte 3	Control Output 5B							
	Byte 4	Spare				Control Output 5B			
	Byte 5	Control Output 6A							
	Byte 6	Spare				Control Output 6A			
	Byte 7	Control Output 6B							
	Byte 8	Spare				Control Output 6B			

NOTE: Data Panel uses little-endian bit ordering

* See *Source Address and SA-Specific Values* table for offset values

PGN 65311 (0xFF1F*): DP-34044-3

PWM4 Control Message									
Data Type		Bit 8	Bit 7	Bit 6	Bit 5	Bit 4	Bit 3	Bit 2	Bit 1
Word	Byte 1	Control Output 7A							
	Byte 2	Spare				Control Output 7A			
	Byte 3	Control Output 7B							
	Byte 4	Spare				Control Output 7B			
	Byte 5	Control Output 8A							
	Byte 6	Spare				Control Output 8A			
	Byte 7	Control Output 8B							
	Byte 8	Spare				Control Output 8B			

NOTE: Data Panel uses little-endian bit ordering

* See *Source Address and SA-Specific Values* table for offset values

PGN 65533 (0xFFFD): DP-34044-4

Amp Data Ports 1, 3 (Output Amperage Feedback)									
Data Type		Bit 8	Bit 7	Bit 6	Bit 5	Bit 4	Bit 3	Bit 2	Bit 1
Word	Byte 1	Output 1A Amp Feedback							
	Byte 2	Spare				Output 1A Amp Feedback			
	Byte 3	Output 1B Amp Feedback							
	Byte 4	Spare				Output 1B Amp Feedback			
	Byte 5	Output 3A Amp Feedback							
	Byte 6	Spare				Output 3A Amp Feedback			
	Byte 7	Output 2B Amp Feedback							
	Byte 8	Spare				Output 3B Amp Feedback			

NOTE: Data Panel uses little-endian bit ordering

Name	Description
Output 1A Amp Feedback	Current reading 1mA per bit
Output 1B Amp Feedback	
Output 3A Amp Feedback	
Output 3B Amp Feedback	

PGN 65523 (0xFF3): DP-34044-1

Amp Data Ports 1-4 (DPLT1 Output Amperage Feedback)									
Data Type		Bit 8	Bit 7	Bit 6	Bit 5	Bit 4	Bit 3	Bit 2	Bit 1
Word	Byte 1	Output 1A Amp Feedback							
	Byte 2	Spare				Output 1A Amp Feedback			
	Byte 3	Output 1B Amp Feedback							
	Byte 4	Spare				Output 1B Amp Feedback			
	Byte 5	Output 2A Amp Feedback							
	Byte 6	Spare				Output 2A Amp Feedback			
	Byte 7	Output 2B Amp Feedback							
	Byte 8	Spare				Output 2B Amp Feedback			

NOTE: Data Panel uses little-endian bit ordering

Name	Description
Output 1A Amp Feedback	Current reading on the output, 0-4,000 = 0-4000 mA
Output 1B Amp Feedback	
Output 2A Amp Feedback	
Output 2B Amp Feedback	

PGN 65523 (0xFF3): DP-34044-4

Amp Data Ports 2, 4 (DPLT1 Output Amperage Feedback)									
Data Type		Bit 8	Bit 7	Bit 6	Bit 5	Bit 4	Bit 3	Bit 2	Bit 1
Word	Byte 1	Output 2A Amp Feedback							
	Byte 2	Spare				Output 2A Amp Feedback			
	Byte 3	Output 2B Amp Feedback							
	Byte 4	Spare				Output 2B Amp Feedback			
	Byte 5	Output 4A Amp Feedback							
	Byte 6	Spare				Output 4A Amp Feedback			
	Byte 7	Output 4B Amp Feedback							
	Byte 8	Spare				Output 4B Amp Feedback			

NOTE: Data Panel uses little-endian bit ordering

Name	Description
Output 2A Amp Feedback	Current reading on the output, 0-4,000 = 0-4000 mA
Output 2B Amp Feedback	
Output 4A Amp Feedback	
Output 4B Amp Feedback	

PGN 65523 (0xFF3): DP-34044-3, -5

Amp Data Ports 1-8 (DPLT1 Output Amperage Feedback)									
Data Type		Bit 8	Bit 7	Bit 6	Bit 5	Bit 4	Bit 3	Bit 2	Bit 1
Byte	Byte 1	Output 1A Amp Feedback							
	Byte 2	Output 1B Amp Feedback							
	Byte 3	Output 2A Amp Feedback							
	Byte 4	Output 2B Amp Feedback							
	Byte 5	Output 3A Amp Feedback							
	Byte 6	Output 3B Amp Feedback							
	Byte 7	Output 4A Amp Feedback							
	Byte 8	Output 4B Amp Feedback							

NOTE: Data Panel uses little-endian bit ordering

Name	Applicable Variants	Description
Output 1A Amp Feedback	DP-34044-3, -5	Current reading on the port, Amp Data Range 0.0 to 22.0 Amps [0 – 220 decimal]
Output 1B Amp Feedback		
Output 2A Amp Feedback		
Output 2B Amp Feedback		
Output 3A Amp Feedback		
Output 3B Amp Feedback		
Output 4A Amp Feedback		
Output 4B Amp Feedback		

PGN 65524 (0xFF4): DP-34044-1

Amp Data Ports 5-8 (DPLT2 Output Amperage Feedback)									
Data Type		Bit 8	Bit 7	Bit 6	Bit 5	Bit 4	Bit 3	Bit 2	Bit 1
Word	Byte 1	Output 3A Amp Feedback							
	Byte 2	Spare				Output 3A Amp Feedback			
	Byte 3	Output 3B Amp Feedback							
	Byte 4	Spare				Output 3B Amp Feedback			
	Byte 5	Output 4A Amp Feedback							
	Byte 6	Spare				Output 4A Amp Feedback			
	Byte 7	Output 4B Amp Feedback							
	Byte 8	Spare				Output 4B Amp Feedback			

NOTE: Data Panel uses little-endian bit ordering

Name	Description
Output 3A Amp Feedback	Current reading on the output, 0-4,000 = 0-4000 mA
Output 3B Amp Feedback	
Output 4A Amp Feedback	
Output 4B Amp Feedback	

PGN 65524 (0xFFF4): DP-34044-4

Amp Data Ports 5-8 (DPLT2 Output Amperage Feedback)									
Data Type		Bit 8	Bit 7	Bit 6	Bit 5	Bit 4	Bit 3	Bit 2	Bit 1
Word	Byte 1	Output 5 Amp Feedback							
	Byte 2	Spare				Output 5 Amp Feedback			
	Byte 3	Output 6 Amp Feedback							
	Byte 4	Spare				Output 6 Amp Feedback			
	Byte 5	Output 7 Amp Feedback							
	Byte 6	Spare				Output 7 Amp Feedback			
	Byte 7	Output 8 Amp Feedback							
	Byte 8	Spare				Output 8 Amp Feedback			

NOTE: Data Panel uses little-endian bit ordering

Name	Description
Output 5 Amp Feedback	Amp Data: 0.000 to 10.000 Amps Data Range: 0 – 10,000 Decimal Resolution: 1 mAmp / Bit
Output 6 Amp Feedback	
Output 7 Amp Feedback	
Output 7 Amp Feedback	

PGN 65524 (0xFFF4): DP-34044-3, -5

Amp Data Ports 9-16 (DPLT2 Output Amperage Feedback)									
Data Type		Bit 8	Bit 7	Bit 6	Bit 5	Bit 4	Bit 3	Bit 2	Bit 1
Byte	Byte 1	Output 5A Amp Feedback							
	Byte 2	Output 5B Amp Feedback							
	Byte 3	Output 6A Amp Feedback							
	Byte 4	Output 6B Amp Feedback							
	Byte 5	Output 7A Amp Feedback							
	Byte 6	Output 7B Amp Feedback							
	Byte 7	Output 8A Amp Feedback							
	Byte 8	Output 8B Amp Feedback							

NOTE: Data Panel uses little-endian bit ordering

Name	Applicable Variants	Description
Output 5A Amp Feedback	DP-34044-3, -5	Current reading on the port, Amp Data Range 0.0 to 22.0 Amps [0 – 220 decimal]
Output 5B Amp Feedback		
Output 6A Amp Feedback		
Output 6B Amp Feedback		
Output 7A Amp Feedback		
Output 7B Amp Feedback		
Output 8A Amp Feedback		
Output 8B Amp Feedback		

CANopen Configuration

CONFIGURATION NOTES

Use of Index

CANopen prescribes a basic functionality for each module. Further functions can be installed but must adhere to the specifications in the module and communication profile. The specification of the module properties is done in the object dictionary. The object dictionary is set up in the application area of the module. The structure of the object dictionary can be taken from the following table. In the area between 0x1000 and 0x1FFF are the data of the communication profile and between 0x6000 and 0x9FFF the data of the module profile.

To Export the DCF file, the EDS file must first be opened and then the DCF file can be exported.

Communication Profile

The communication profile is based on the services and protocols provided by CAL. It contains functions for distributed synchronous operations, provides a common time base and defines uniform error signaling. Application objects can be assigned to communication objects. The communication profile also defines system initialization. Four message types (objects) are distinguished in the CANopen communication model:

These messages include layer management (LMT), network management (NMT) and identifier assignment (DBT). They are implemented via CAL management services.

The Service Data Objects (SDO) are used to read and write entries in the object dictionary of the modules. The SDOs are realized by CAL application services. Each CANopen module supports at least one SDO server.

The transfer of Process Data Objects (PDO) is the fastest way to transfer data since the transfer takes place without an additional protocol. A distinction is made between synchronous and asynchronous transmission. The PDOs are realized by CAL application services.

There are three predefined communication objects. SYNC, Time Stamp and Emergency Object. The support of these objects is not mandatory. They are implemented via CAL application services.

Process Data Objects (PDO)

This Module uses 1 Receive PDOs and 10 Transmit PDOs. The PDO 1 to 4 are used to transmit the Digital and Analog Inputs. By Default, the interrupt source 6423 is enabled and the mapped digital and analog input are transmitted on change of state. The object 6426 shall set the delta value which is the difference from the last transmitted value. If the current value of the analog input is above or below by this delta value, then the PDOs is transmitted. These values can be changed and saved. These PDOs can be set to be transmitted on a fixed Transmission rate by setting the Event Timer of the corresponding PDO.

The PDO 5 to 10 are used to transmit the Status, Response and Fault messages. These PDOs are not transmitted by default. The Transmission rate of the PDOs can be changed using Sub Index 5: Event Timer of the PDOs. In case for RPDO, Sub Index 5: Event Timer can be used for Output timeout. If the Module does not receive RPDO in the set Event Time, the output will timeout and will be turned off. CANopen offers a wide range of options for transmitting process data.

The PDO transmission types are explained in more detail below:

The “Change of State” is the change of an input value (event control). The data is sent immediately after a change on the BUS. The event control makes optimum use of the bus bandwidth, since the entire process image is not constantly transmitted, but only the change to it. At the same time, a short reaction time is achieved, since when an input value is changed, it is not necessary to wait for the next query by a master.

When selecting the “Change of State” PDO transmission, however, it must be taken into account that under certain circumstances many events may occur simultaneously and corresponding delay times may then occur until a relatively low priority PDO can be sent on the BUS. A constantly changing input with a high priority PDO may block the BUS (“babbling-idiot”), which must be prevented. For this reason, the event control for analog inputs is switched off by default according to the CANopen specification and must be activated via object 0x2001.

PDOs can also be polarized by data request telegrams (remote frames, RTR telegrams) by the master. In this way, the input process image can also be brought to the BUS without input change in the case of event-controlled inputs, such as a monitor or diagnostics module being added to the network during runtime.

Index	Object
0x0000	Not used
0x0001 - 0x001F	Static Data Types
0x0020 - 0x003F	Complex Data Types
0x0040 - 0x005F	Manufacturer-Specific Data Types
0x0060 - 0x0025F	Device Profile-Specific Data Types
0x0260 - 0x0FFF	Reserved for further use
0x1000 - 0x1FFF	Communication Profile Area
0x2000 - 0x5FFF	Manufacturer-Specific Profile Area
0x6000 - 0x9FFF	Standardized Device Profile Area
0xA000 - 0xAFFF	Standardized Network Variable Area
0xB000 - 0xBFFF	Standardized System Variable Area
0xC000 - 0xFFFF	Reserved for further use

Store/Restore Parameters

✓ signifies that the applicable sub-index has Store/Restore capabilities. When applied to an entire message, all message bytes have Store/Restore capabilities. User can store and load application settings by writing the value 0x65766173 to object index 1010h. User can restore the factory default values by writing the value 0x64616F6C to the object index 1011h.

Emergency Message Format

Data Type		Bit 8	Bit 7	Bit 6	Bit 5	Bit 4	Bit 3	Bit 2	Bit 1
Word	Byte 0	Emergency Code							
	Byte 1								
Byte	Byte 2	Error Register							
	Byte 3	Manufacturer-Specific Error Field							
	Byte 4								
	Byte 5								
	Byte 6								
	Byte 7								

Emergency Code	Description	Manufacturer Specific Error Code				
		Byte 3	Byte 4	Byte 5	Byte 6	Byte 7
0000h	Error reset or no error	0	0	0	0	0
0106h	Duplicate Node ID	Node ID	0	0	0	0
1000h	Generic error	1	0	0	0	0
2310h	Current at outputs too high (overload)	Port	Port	0	0	0
3110h	Input voltage too high	Voltage		0	0	0
3120h	Input voltage too low	Voltage		0	0	0
3210h	Internal voltage too high	0	0	0	0	0
4200h	Device temperature – generic	Temperature		0	0	0
6000h	CANopen device software – generic error	Type	Location	0	0	0

Heartbeat

A Heartbeat producer cyclically transmits a Heartbeat message. By default, the heartbeat producer time is set at 2000ms. This can be changed by setting the time in object 1017h, sub-index 0.

The COB-ID that is used is 0700h + Node ID

The Heartbeat Producer gives its status, which can be any of the following values, in the first byte of the message:

- 00h BOOTUP
- 04h STOPPED
- 05h OPERATIONAL
- 7Fh PRE-OPERATIONAL

Digital Control / Status Bit Pairs	
00	OFF / FALSE
01	ON / TRUE
10	NOT USED
11	NOT USED

INDEX REFERENCE BY VARIANT

Index	DP-34044-1	DP-34044-2	DP-34044-3	DP-34044-4	DP-34044-5
1000	X*	X	X	X	X
1001	X	X	X	X	X
1003	X	X	X	X	X
1008	X	X	X	X	X
1009	X	X	X	X	X
100A	X	X	X	X	X
1010	X	X	X	X	X
1011	X	X	X	X	X
1014	X	X	X	X	X
1015	X	X	X	X	X
1017	X	X	X	X	X
1018	X	X	X	X	X
1200	X	X	X	X	X
1400	X	X	X	X	X
1401	X	N/A	X	X	N/A
1402	X	N/A	X	X	N/A
1403	N/A	N/A	X	X	N/A
1404	N/A	N/A	X	X	N/A
1600	X	X	X	X	X
1601	X	N/A	X	X	N/A
1602	X	N/A	X	X	N/A
1603	N/A	N/A	X	X	N/A
1604	N/A	N/A	X	N/A	N/A
1800	X	X	N/A	N/A	N/A
1801	X	X	N/A	N/A	N/A
1802	X	X	N/A	N/A	N/A
1803	X	X	N/A	N/A	N/A
1804	X	X	X	X	X
1805	X	X	X	X	X
1806	X	X	X	X	X
1807	X	X	X	X	X
1808	X	X	X	X	X
1809	X	X	X	X	X

Index	DP-34044-1	DP-34044-2	DP-34044-3	DP-34044-4	DP-34044-5
180A	N/A	N/A	X	X	N/A
180B	N/A	N/A	X	N/A	N/A
1A00	X	X	N/A	N/A	N/A
1A01	X	X	N/A	N/A	N/A
1A02	X	X	N/A	N/A	N/A
1A03	X	X	N/A	N/A	N/A
1A04	X	X	X	X	X
1A05	X	X	X	X	X
1A06	X	X	X	X	X
1A07	X	X	X	X	X
1A08	X	X	X	X	X
1A09	X	X	X	X	X
1A0A	N/A	N/A	X	X	N/A
1A0B	N/A	N/A	X	N/A	N/A
2000	X	X	X	X	X
2001	X	X	X	X	N/A
2002	X	N/A	X	X	N/A
2003	X	X	N/A	N/A	N/A
2004	N/A	N/A	X	X	X
2005	N/A	X	N/A	X	N/A
3000	X	N/A	X	X	N/A
3001	X	N/A	N/A	N/A	N/A
5000	X	X	X	X	X
5001	X	X	X	X	X
5002	X	X	X	X	X
5003	X	N/A	X	X	X
5004	X	X	X	X	X
6000	X	X	N/A	N/A	N/A
6200	X	X	X	X	X
6401	X	X	N/A	N/A	N/A
6411	X	N/A	X	X	N/A
6423	X	X	N/A	N/A	N/A
6426	X	X	N/A	N/A	N/A

* X indicates that there is an applicable index for this variant. Click on the X to jump to the corresponding page.

RECEIVE PDO

Index	Mapped Index	Applicable Variant	Mapped Sub-Index	Object	Function	Message	COB-ID
1400	6200	DP-34044-1	1-3	RPDO1	Digital Output	Write Outputs 8 Bit	0x200+NodeID
		DP-34044-2, -3, -4, -5	1-2				
1401	6411	DP-34044-1, -3, -4	1-4	RPDO2	Analog Output	Write Analog Output 16 Bit	0x300+NodeID
1402	6411		5-8	RPDO3	Analog Output	Write Analog Output 16 Bit	0x400+NodeID
1403	6411	DP-34044-3	9-12	RPDO4	Analog Output	Write Analog Output 16 Bit	0x500+NodeID
	2005	DP-34044-4	1	RPDO4	Output Direction	Direction Bits	0x500+NodeID
1404	6411	DP-34044-3	13-16	RPDO5	Analog Output	Write Analog Output 16 Bit	0x220+NodeID

TRANSMIT PDO

Index	Mapped Index	Applicable Variant	Mapped Sub-Index	Object	Function	Message	COB-ID
1800	6000	DP-34044-1	1-1	TPDO1	Digital Input	Read Input 8-Bit	0x180+NodeID
		DP-34044-2	1-2				
1801	6401	DP-34044-1, -2	1-4	TPDO2	Analog Input	Read Analogue Input 16-Bit	0x280+NodeID
1802	6401		5-8	TPDO3	Analog Input	Read Analogue Input 16-Bit	0x380+NodeID
1803	6401		9-12	TPDO4	Analog Input	Read Analogue Input 16-Bit	0x480+NodeID
1804	5000	DP-34044-1	1-4	TPDO5	Status Message	Response Message	0x1A0+NodeID
		DP-34044-3, -4, -5			PropA Response		
	6401	DP-34044-2	13-16		Analog Input	Read Analogue Input 16-Bit	
1805	5001	DP-34044-1, -3, -4, -5	1-8	TPDO6	Status Message	Status Message F1	0x1C0+NodeID
	6401	DP-34044-2	17-20		Analog Input	Read Analogue Input 16-Bit	
1806	5002	DP-34044-1, -3, -4, -5	1-4	TPDO7	Status Message	Status Message F2	0x1E0+NodeID
	5000	DP-34044-2				Response Message	
1807	5003	DP-34044-1, -3, -4	1-4	TPDO8	Status Message	Status Message Amp Data	0x2A0+NodeID
		DP-34044-5	1-8			Status Message F1	
	5001	DP-34044-2					
1808	5003	DP-34044-1, -3, -4	5-8	TPDO9	Status Message	Status Message Amp Data	0x2C0+NodeID
		DP-34044-5	9-16			Status Message F2	
	5002	DP-34044-2	1-4				
1809	5004	DP-34044-1, -2, -5	1-8	TPDO10	Fault Message	Fault Message	0x2E0+NodeID
		DP-34044-4			Status Message	Status Message Amp Data	
	5003	DP-34044-3					
180A	5003	DP-34044-3	13-16	TPDO11	Status Message	Status Message Amp Data	0x3A0+NodeID
		DP-34044-4	1-8		Fault Message	Fault Message	
180B	5004	DP-34044-3	1-8	TPDO12	Fault Message	Fault Message	0x3C0+NodeID

COMMUNICATION SEGMENT

Index	Applicable Variant	Name	Sub-Index	Data Type	Description	Access	Default Value
1000	ALL	Device Type		UNSIGNED32		RO	0x000F0191
1001		Error Register		UNSIGNED8		RO	0x00
1003		Pre-defined Error Field	0	UNSIGNED32	Number of Errors	RW	0x00000000
			1	UNSIGNED32	Standard Error Field	RO	0x00000000
			2	UNSIGNED32	Standard Error Field_2	RO	0x00000000
			3	UNSIGNED32	Standard Error Field_3	RO	0x00000000
			4	UNSIGNED32	Standard Error Field_4	RO	0x00000000
			5	UNSIGNED32	Standard Error Field_5	RO	0x00000000
1008		Manufacturer Device Name		VISIBLE_STRING		CONST	34044_X*_200
1009		Manufacturer Hardware Version		VISIBLE_STRING		CONST	34044_20X*
100A		Manufacturer Software Version		VISIBLE_STRING		CONST	01.0E
1010		Store Parameter Field	0	UNSIGNED32	Highest sub-index supported	RO	0x03
			1	UNSIGNED32	Save all Parameters	RW	0x00000000
			2	UNSIGNED32	Save Communication Parameters	RW	0x00000000
			3	UNSIGNED32	Save Application Parameters	RW	0x00000000
1011		Restore Default Parameters	0	UNSIGNED32	Highest sub-index supported	RO	0x03
			1	UNSIGNED32	Restore all Default Parameters	RW	0x00000000
			2	UNSIGNED32	Restore Communication Default Parameters	RW	0x00000000
			3	UNSIGNED32	Restore Application Default Parameters	RW	0x00000000
1014		COB-ID EMCY		UNSIGNED32		RO	0x00000080
1015	Inhibit Time Emergency		UNSIGNED16		RW	0x0000 ✓	
1017	Producer Heartbeat Time		UNSIGNED16		RW	0x07D0 ✓	
1018	Identity Object	0	IDENTITY	Number of entries	RO	0x04	
		1	UNSIGNED32	Vendor ID	RO	0x000004FB	
		2	UNSIGNED32	Product Code	RO	0x340441	
		3	UNSIGNED32	Revision number	RO	0x0001000E	
		4	UNSIGNED32	Serial number	RO	0x0	
1200	Server SDO Parameter 1	0	SDO_PARAMETER	Highest sub-index supported	RO	0x02	
		1	UNSIGNED32	COB-ID Client -> Server	RO	600h+NodeID	
		2	UNSIGNED32	COB-ID Server -> Client	RO	580h+NodeID	

NOTE: Data Panel uses little-endian bit ordering

* X=Variant number (1-5)

COMMUNICATION SEGMENT (continued)

Index	Applicable Variant	Name	Sub-Index	Data Type	Description	Access	Default Value
1400	ALL	Receive PDO Communication Parameter 1	0	PDO_COMM_PAR	Highest sub-index supported	RO	0x05
			1	UNSIGNED32	COB-ID	RW	0x200+NodeID
			2	UNSIGNED8	Transmission Type	RW	0xFF
			3	UNSIGNED16	Inhibit Time	RW	0x0
			4	UNSIGNED8	Compatibility Entry	RW	0x00
			5	UNSIGNED16	Event Timer	RW	0x0 ✓
1401	DP-34044-1, -3, -4	Receive PDO Communication Parameter 2	0	PDO_COMM_PAR	Highest sub-index supported	RO	0x05
			1	UNSIGNED32	COB-ID	RW	0x300+NodeID
			2	UNSIGNED8	Transmission Type	RW	0xFF
			3	UNSIGNED16	Inhibit Time	RW	0x0
			4	UNSIGNED8	Compatibility Entry	RW	0x00
			5	UNSIGNED16	Event Timer	RW	0x0 ✓
1402	DP-34044-1, -3, -4	Receive PDO Communication Parameter 3	0	PDO_COMM_PAR	Highest sub-index supported	RO	0x05
			1	UNSIGNED32	COB-ID	RW	0x400+NodeID
			2	UNSIGNED8	Transmission Type	RW	0xFF
			3	UNSIGNED16	Inhibit Time	RW	0x0
			4	UNSIGNED8	Compatibility Entry	RW	0x00
			5	UNSIGNED16	Event Timer	RW	0x0 ✓
1403	DP-34044-3, -4	Receive PDO Communication Parameter 4	0	PDO_COMM_PAR	Highest sub-index supported	RO	0x05
			1	UNSIGNED32	COB-ID	RW	0x500+NodeID
			2	UNSIGNED8	Transmission Type	RW	0xFF
			3	UNSIGNED16	Inhibit Time	RW	0x0
			4	UNSIGNED8	Compatibility Entry	RW	0x00
			5	UNSIGNED16	Event Timer	RW	0x0 ✓
1404	DP-34044-3	Receive PDO Communication Parameter 5	0	PDO_COMM_PAR	Highest sub-index supported	RO	0x05
			1	UNSIGNED32	COB-ID	RW	0x220+NodeID
			2	UNSIGNED8	Transmission Type	RW	0xFF
			3	UNSIGNED16	Inhibit Time	RW	0x0
			4	UNSIGNED8	Compatibility Entry	RW	0x00
			5	UNSIGNED16	Event Timer	RW	0x0 ✓

NOTE: Data Panel uses little-endian bit ordering

COMMUNICATION SEGMENT (continued)

Index	Applicable Variant	Name	Sub-Index	Data Type	Description	Access	Default Value
1600	ALL	Receive PDO Mapping Parameter 1	0	PDO_COMM_PAR	Number of mapped objects	CONST	0x03
			1	UNSIGNED32	Mapping Entry 1	CONST	0x62000108
			2	UNSIGNED32	Mapping Entry 2	CONST	0x62000208
			3	UNSIGNED32	Mapping Entry 3	CONST	0x62000308
1601	DP-34044-1, -3, -4	Receive PDO Mapping Parameter 2	0	PDO_COMM_PAR	Number of mapped objects	CONST	0x04
			1	UNSIGNED32	Mapping Entry 1	CONST	0x64110110
			2	UNSIGNED32	Mapping Entry 2	CONST	0x64110210
			3	UNSIGNED32	Mapping Entry 3	CONST	0x64110310
			4	UNSIGNED32	Mapping Entry 4	CONST	0x64110410
1602	DP-34044-1, -3, -4	Receive PDO Mapping Parameter 3	0	PDO_COMM_PAR	Number of mapped objects	CONST	0x04
			1	UNSIGNED32	Mapping Entry 1	CONST	0x64110510
			2	UNSIGNED32	Mapping Entry 2	CONST	0x64110610
			3	UNSIGNED32	Mapping Entry 3	CONST	0x64110710
			4	UNSIGNED32	Mapping Entry 3	CONST	0x64110810
1603	DP-34044-3, -4	Receive PDO Mapping Parameter 4	0	PDO_MAPPING	Number of mapped objects	CONST	0x04
			1	UNSIGNED32	Mapping Entry 1	CONST	0x64110910
			2	UNSIGNED32	Mapping Entry 2	CONST	0x64110A10
			3	UNSIGNED32	Mapping Entry 3	CONST	0x64110B10
			4	UNSIGNED32	Mapping Entry 4	CONST	0x64110C10
1604	DP-34044-3	Receive PDO Mapping Parameter 5	0	PDO_MAPPING	Number of mapped objects	CONST	0x04
			1	UNSIGNED32	Mapping Entry 1	CONST	0x64110D10
			2	UNSIGNED32	Mapping Entry 2	CONST	0x64110E10
			3	UNSIGNED32	Mapping Entry 3	CONST	0x64110F10
			4	UNSIGNED32	Mapping Entry 4	CONST	0x64111010

NOTE: Data Panel uses little-endian bit ordering

COMMUNICATION SEGMENT (continued)

Index	Applicable Variant	Name	Sub-Index	Data Type	Description	Access	Default Value		
1800	DP-34044-1, -2	Transmit PDO Communication Parameter 1	0	PDO_COMM_PAR	Highest sub-index supported	RO	0x05		
			1	UNSIGNED32	COB-ID	RW	0x180+NodeID		
			2	UNSIGNED8	Transmission Type	RW	0xFF		
			3	UNSIGNED16	Inhibit Time	RW	0x0		
			4	UNSIGNED8	Compatibility Entry	RW	0x00		
			5	UNSIGNED16	Event Timer	RW	0x0 ✓		
1801		DP-34044-1, -2	Transmit PDO Communication Parameter 2	0	PDO_COMM_PAR	Highest sub-index supported	RO	0x05	
				1	UNSIGNED32	COB-ID	RW	0x280+NodeID	
				2	UNSIGNED8	Transmission Type	RW	0xFF	
				3	UNSIGNED16	Inhibit Time	RW	0x0	
				4	UNSIGNED8	Compatibility Entry	RW	0x00	
				5	UNSIGNED16	Event Timer	RW	0x0 ✓	
1802			DP-34044-1, -2	Transmit PDO Communication Parameter 3	0	PDO_COMM_PAR	Highest sub-index supported	RO	0x05
					1	UNSIGNED32	COB-ID	RW	0x380+NodeID
					2	UNSIGNED8	Transmission Type	RW	0xFF
					3	UNSIGNED16	Inhibit Time	RW	0x0
					4	UNSIGNED8	Compatibility Entry	RW	0x00
					5	UNSIGNED16	Event Timer	RW	0x0 ✓
1803	DP-34044-1, -2			Transmit PDO Communication Parameter 4	0	PDO_COMM_PAR	Highest sub-index supported	RO	0x05
					1	UNSIGNED32	COB-ID	RW	0x480+NodeID
					2	UNSIGNED8	Transmission Type	RW	0xFF
					3	UNSIGNED16	Inhibit Time	RW	0x0
					4	UNSIGNED8	Compatibility Entry	RW	0x00
					5	UNSIGNED16	Event Timer	RW	0x0 ✓
1804		ALL		Transmit PDO Communication Parameter 5	0	PDO_COMM_PAR	Highest sub-index supported	RO	0x05
					1	UNSIGNED32	COB-ID	RW	0x1A0+NodeID
					2	UNSIGNED8	Transmission Type	RW	0xFE
					3	UNSIGNED16	Inhibit Time	RW	0x0
					4	UNSIGNED8	Compatibility Entry	RW	0x00
					5	UNSIGNED16	Event Timer	RW	0x0 ✓
1805			ALL	Transmit PDO Communication Parameter 6	0	PDO_COMM_PAR	Highest sub-index supported	RO	0x05
					1	UNSIGNED32	COB-ID	RW	0x1C0+NodeID
					2	UNSIGNED8	Transmission Type	RW	0xFE
					3	UNSIGNED16	Inhibit Time	RW	0x0
					4	UNSIGNED8	Compatibility Entry	RW	0x00
					5	UNSIGNED16	Event Timer	RW	0x0 ✓
1806	ALL			Transmit PDO Communication Parameter 7	0	PDO_COMM_PAR	Highest sub-index supported	RO	0x05
					1	UNSIGNED32	COB-ID	RW	0x1E0+NodeID
					2	UNSIGNED8	Transmission Type	RW	0xFE
					3	UNSIGNED16	Inhibit Time	RW	0x0
					4	UNSIGNED8	Compatibility Entry	RW	0x00
					5	UNSIGNED16	Event Timer	RW	0x0 ✓

NOTE: Data Panel uses little-endian bit ordering

COMMUNICATION SEGMENT (continued)

Index	Applicable Variant	Name	Sub-Index	Data Type	Description	Access	Default Value
1807	ALL	Transmit PDO Communication Parameter 8	0	PDO_COMM_PAR	Highest sub-index supported	RO	0x05
			1	UNSIGNED32	COB-ID	RW	0x2A0+NodeID
			2	UNSIGNED8	Transmission Type	RW	0xFF
			3	UNSIGNED16	Inhibit Time	RW	0x0
			4	UNSIGNED8	Compatibility Entry	RW	0x00
			5	UNSIGNED16	Event Timer	RW	0x0 ✓
1808		Transmit PDO Communication Parameter 9	0	PDO_COMM_PAR	Highest sub-index supported	RO	0x05
			1	UNSIGNED32	COB-ID	RW	0x2C0+NodeID
			2	UNSIGNED8	Transmission Type	RW	0xFF
			3	UNSIGNED16	Inhibit Time	RW	0x0
			4	UNSIGNED8	Compatibility Entry	RW	0x00
			5	UNSIGNED16	Event Timer	RW	0x0 ✓
1809		Transmit PDO Communication Parameter 10	0	PDO_COMM_PAR	Highest sub-index supported	RO	0x05
			1	UNSIGNED32	COB-ID	RW	0x2E0+NodeID
			2	UNSIGNED8	Transmission Type	RW	0xFF
			3	UNSIGNED16	Inhibit Time	RW	0x0
			4	UNSIGNED8	Compatibility Entry	RW	0x00
			5	UNSIGNED16	Event Timer	RW	0x0 ✓
180A	DP-34044-3, -4	Transmit PDO Communication Parameter 11	0	PDO_COMM_PAR	Highest sub-index supported	RO	0x05
			1	UNSIGNED32	COB-ID	RW	0x3A0+NodeID
			2	UNSIGNED8	Transmission Type	RW	0xFF
			3	UNSIGNED16	Inhibit Time	RW	0x0
			4	UNSIGNED8	Compatibility Entry	RW	0x00
			5	UNSIGNED16	Event Timer	RW	0x0 ✓
180B	DP-34044-3	Transmit PDO Communication Parameter 12	0	PDO_COMM_PAR	Highest sub-index supported	RO	0x05
			1	UNSIGNED32	COB-ID	RW	0x3C0+NodeID
			2	UNSIGNED8	Transmission Type	RW	0xFE
			3	UNSIGNED16	Inhibit Time	RW	0x0
			4	UNSIGNED8	Compatibility Entry	RW	0x00
			5	UNSIGNED16	Event Timer	RW	0x0 ✓

NOTE: Data Panel uses little-endian bit ordering

COMMUNICATION SEGMENT (continued)

Index	Applicable Variant	Name	Sub-Index	Data Type	Description	Access	Default Value
1A00	DP-34044-1	Transmit PDO Mapping Parameter 1	0	PDO_MAPPING	Number of mapped objects	CONST	0x01
			1	UNSIGNED32	Mapping Entry 1	CONST	0x60000108
	DP-34044-2		0	PDO_MAPPING	Number of mapped objects	CONST	0x02
			1	UNSIGNED32	Mapping Entry 1	CONST	0x60000108
			2	UNSIGNED32	Mapping Entry 2	CONST	0x60000208
1A01		Transmit PDO Mapping Parameter 2	0	PDO_MAPPING	Number of mapped objects	CONST	0x04
			1	UNSIGNED32	Mapping Entry 1	CONST	0x64010110
			2	UNSIGNED32	Mapping Entry 2	CONST	0x64010210
			3	UNSIGNED32	Mapping Entry 3	CONST	0x64010310
			4	UNSIGNED32	Mapping Entry 4	CONST	0x64010410
1A02	DP-34044-1, -2	Transmit PDO Mapping Parameter 3	0	PDO_MAPPING	Number of mapped objects	CONST	0x04
			1	UNSIGNED32	Mapping Entry 1	CONST	0x64010510
			2	UNSIGNED32	Mapping Entry 2	CONST	0x64010610
			3	UNSIGNED32	Mapping Entry 3	CONST	0x64010710
			4	UNSIGNED32	Mapping Entry 4	CONST	0x64010810
1A03		Transmit PDO Mapping Parameter 4	0	PDO_MAPPING	Number of mapped objects	CONST	0x04
			1	UNSIGNED32	Mapping Entry 1	CONST	0x64010910
			2	UNSIGNED32	Mapping Entry 2	CONST	0x64010A10
			3	UNSIGNED32	Mapping Entry 3	CONST	0x64010B10
			4	UNSIGNED32	Mapping Entry 4	CONST	0x64010C10
1A04	DP-34044-1, -3, -4, -5	Transmit PDO Mapping Parameter 5	0	PDO_MAPPING	Number of mapped objects	CONST	0x04
			1	UNSIGNED32	Mapping Entry 1	CONST	0x50000108
			2	UNSIGNED32	Mapping Entry 2	CONST	0x50000208
			3	UNSIGNED32	Mapping Entry 3	CONST	0x50000308
			4	UNSIGNED32	Mapping Entry 4	CONST	0x50000408
	DP-34044-2		0	PDO_MAPPING	Number of mapped objects	CONST	0x04
			1	UNSIGNED32	Mapping Entry 1	CONST	0x64010D10
			2	UNSIGNED32	Mapping Entry 2	CONST	0x64010E10
			3	UNSIGNED32	Mapping Entry 3	CONST	0x64010F10
1A05	DP-34044-1, -3, -4, -5	Transmit PDO Mapping Parameter 6	0	PDO_MAPPING	Number of mapped objects	CONST	0x08
			1	UNSIGNED32	Mapping Entry 1	CONST	0x50010108
			2	UNSIGNED32	Mapping Entry 2	CONST	0x50010208
			3	UNSIGNED32	Mapping Entry 3	CONST	0x50010308
			4	UNSIGNED32	Mapping Entry 4	CONST	0x50010408
			5	UNSIGNED32	Mapping Entry 5	CONST	0x50010508
			6	UNSIGNED32	Mapping Entry 6	CONST	0x50010608
			7	UNSIGNED32	Mapping Entry 7	CONST	0x50010708
	8		UNSIGNED32	Mapping Entry 8	CONST	0x50010808	
	DP-34044-2		0	PDO_MAPPING	Number of mapped objects	CONST	0x04
			1	UNSIGNED32	Mapping Entry 1	CONST	0x64011110
			2	UNSIGNED32	Mapping Entry 2	CONST	0x64011210
			3	UNSIGNED32	Mapping Entry 3	CONST	0x64011310
4		UNSIGNED32	Mapping Entry 4	CONST	0x64011410		

NOTE: Data Panel uses little-endian bit ordering

COMMUNICATION SEGMENT (continued)

Index	Applicable Variant	Name	Sub-Index	Data Type	Description	Access	Default Value
1A06	DP-34044-1, -3, -4, -5	Transmit PDO Mapping Parameter 7	0	PDO_MAPPING	Number of mapped objects	CONST	0x04
			1	UNSIGNED32	Mapping Entry 1	CONST	0x50020110
			2	UNSIGNED32	Mapping Entry 2	CONST	0x50020210
			3	UNSIGNED32	Mapping Entry 3	CONST	0x50020310
			4	UNSIGNED32	Mapping Entry 4	CONST	0x50020410
	DP-34044-2		0	PDO_MAPPING	Number of mapped objects	CONST	0x04
			1	UNSIGNED32	Mapping Entry 1	CONST	0x50000108
			2	UNSIGNED32	Mapping Entry 2	CONST	0x50000208
			3	UNSIGNED32	Mapping Entry 3	CONST	0x50000308
			4	UNSIGNED32	Mapping Entry 4	CONST	0x50000408
1A07	DP-34044-1, -3, -4	Transmit PDO Mapping Parameter 8	0	PDO_MAPPING	Number of mapped objects	CONST	0x04
			1	UNSIGNED32	Mapping Entry 1	CONST	0x50030110
			2	UNSIGNED32	Mapping Entry 2	CONST	0x50030210
			3	UNSIGNED32	Mapping Entry 3	CONST	0x50030310
			4	UNSIGNED32	Mapping Entry 4	CONST	0x50030410
	DP-34044-2		0	PDO_MAPPING	Number of mapped objects	CONST	0x08
			1	UNSIGNED32	Mapping Entry 1	CONST	0x50010108
			2	UNSIGNED32	Mapping Entry 2	CONST	0x50010208
			3	UNSIGNED32	Mapping Entry 3	CONST	0x50010308
			4	UNSIGNED32	Mapping Entry 4	CONST	0x50010408
			5	UNSIGNED32	Mapping Entry 5	CONST	0x50010508
			6	UNSIGNED32	Mapping Entry 6	CONST	0x50010608
			7	UNSIGNED32	Mapping Entry 7	CONST	0x50010708
	DP-34044-5		8	UNSIGNED32	Mapping Entry 8	CONST	0x50010808
			0	PDO_MAPPING	Number of mapped objects	CONST	0x08
			1	UNSIGNED32	Mapping Entry 1	CONST	0x50030108
			2	UNSIGNED32	Mapping Entry 2	CONST	0x50030208
			3	UNSIGNED32	Mapping Entry 3	CONST	0x50030308
			4	UNSIGNED32	Mapping Entry 4	CONST	0x50030408
			5	UNSIGNED32	Mapping Entry 5	CONST	0x50030508
			6	UNSIGNED32	Mapping Entry 6	CONST	0x50030608
			7	UNSIGNED32	Mapping Entry 7	CONST	0x50030708
	8		UNSIGNED32	Mapping Entry 8	CONST	0x50030808	
	1A08		DP-34044-1, -3, -4	Transmit PDO Mapping Parameter 9	0	PDO_MAPPING	Number of mapped objects
1		UNSIGNED32			Mapping Entry 1	CONST	0x50030510
2		UNSIGNED32			Mapping Entry 2	CONST	0x50030610
3		UNSIGNED32			Mapping Entry 3	CONST	0x50030710
4		UNSIGNED32			Mapping Entry 4	CONST	0x50030810
DP-34044-2		0	PDO_MAPPING		Number of mapped objects	CONST	0x04
		1	UNSIGNED32		Mapping Entry 1	CONST	0x50020110
		2	UNSIGNED32		Mapping Entry 2	CONST	0x50020210
		3	UNSIGNED32		Mapping Entry 3	CONST	0x50020310
		4	UNSIGNED32		Mapping Entry 4	CONST	0x50020410

NOTE: Data Panel uses little-endian bit ordering

COMMUNICATION SEGMENT (continued)

Index	Applicable Variant	Name	Sub-Index	Data Type	Description	Access	Default Value
1A08	DP-34044-5	Transmit PDO Mapping Parameter 9	0	PDO_MAPPING	Number of mapped objects	CONST	0x08
			1	UNSIGNED32	Mapping Entry 1	CONST	0x50030908
			2	UNSIGNED32	Mapping Entry 2	CONST	0x50030A08
			3	UNSIGNED32	Mapping Entry 3	CONST	0x50030B08
			4	UNSIGNED32	Mapping Entry 4	CONST	0x50030C08
			0	UNSIGNED32	Mapping Entry 5	CONST	0x50030D08
			1	UNSIGNED32	Mapping Entry 6	CONST	0x50030E08
			2	UNSIGNED32	Mapping Entry 7	CONST	0x50030F08
			3	UNSIGNED32	Mapping Entry 8	CONST	0x50031008
1A09	DP-34044-1, -3, -4	Transmit PDO Mapping Parameter 10	0	PDO_MAPPING	Number of mapped objects	CONST	0x08
			1	UNSIGNED32	Mapping Entry 1	CONST	0x50040108
			2	UNSIGNED32	Mapping Entry 2	CONST	0x50040208
			3	UNSIGNED32	Mapping Entry 3	CONST	0x50040308
			4	UNSIGNED32	Mapping Entry 4	CONST	0x50040408
			5	UNSIGNED32	Mapping Entry 5	CONST	0x50040508
			6	UNSIGNED32	Mapping Entry 6	CONST	0x50040608
			7	UNSIGNED32	Mapping Entry 7	CONST	0x50040708
	8		UNSIGNED32	Mapping Entry 8	CONST	0x50040808	
	DP-34044-2, -5		0	PDO_MAPPING	Number of mapped objects	CONST	0x08
			1	UNSIGNED32	Mapping Entry 1	CONST	0x50040108
			2	UNSIGNED32	Mapping Entry 2	CONST	0x50040208
			3	UNSIGNED32	Mapping Entry 3	CONST	0x50040308
			4	UNSIGNED32	Mapping Entry 4	CONST	0x50040408
			5	UNSIGNED32	Mapping Entry 5	CONST	0x50040508
			6	UNSIGNED32	Mapping Entry 6	CONST	0x50040608
			7	UNSIGNED32	Mapping Entry 7	CONST	0x50040708
8		UNSIGNED32	Mapping Entry 8	CONST	0x50040808		
1A0A	DP-34044-3	Transmit PDO Mapping Parameter 11	0	PDO_MAPPING	Number of mapped objects	CONST	0x04
			1	UNSIGNED32	Mapping Entry 1	CONST	0x50030D10
			2	UNSIGNED32	Mapping Entry 2	CONST	0x50030E10
			3	UNSIGNED32	Mapping Entry 3	CONST	0x50030F10
			4	UNSIGNED32	Mapping Entry 4	CONST	0x50031010
	DP-34044-4		0	PDO_MAPPING	Number of mapped objects	CONST	0x08
			1	UNSIGNED32	Mapping Entry 1	CONST	0x50040108
			2	UNSIGNED32	Mapping Entry 2	CONST	0x50040208
			3	UNSIGNED32	Mapping Entry 3	CONST	0x50040308
			4	UNSIGNED32	Mapping Entry 4	CONST	0x50040408
			5	UNSIGNED32	Mapping Entry 5	CONST	0x50040508
			6	UNSIGNED32	Mapping Entry 6	CONST	0x50040608
			7	UNSIGNED32	Mapping Entry 7	CONST	0x50040708
			8	UNSIGNED32	Mapping Entry 8	CONST	0x50040808

NOTE: Data Panel uses little-endian bit ordering

COMMUNICATION SEGMENT (continued)

Index	Applicable Variant	Name	Sub-Index	Data Type	Description	Access	Default Value
1A0B	DP-34044-3	Transmit PDO Mapping Parameter 12	0	PDO_MAPPING	Number of mapped objects	CONST	0x08
			1	UNSIGNED32	Mapping Entry 1	CONST	0x50040108
			2	UNSIGNED32	Mapping Entry 2	CONST	0x50040208
			3	UNSIGNED32	Mapping Entry 3	CONST	0x50040308
			4	UNSIGNED32	Mapping Entry 4	CONST	0x50040408
			5	UNSIGNED32	Mapping Entry 5	CONST	0x50040508
			6	UNSIGNED32	Mapping Entry 6	CONST	0x50040608
			7	UNSIGNED32	Mapping Entry 7	CONST	0x50040708
			8	UNSIGNED32	Mapping Entry 8	CONST	0x50040808

NOTE: Data Panel uses little-endian bit ordering

MANUFACTURER SEGMENT

Index 2000: All Variants ✓

Global Configuration: DP-34044-1									
Data Type		Bit 8	Bit 7	Bit 6	Bit 5	Bit 4	Bit 3	Bit 2	Bit 1
2 bit	Sub-Index 1	Spare		Spare		Spare		Control Mode Reset	
	Sub-Index 2	Spare		Sensor Power Control		Analog Raw Value		Enable 24V DC	
Byte	Sub-Index 3	Output Mode							
	Sub-Index 4	Input Mode							
	Sub-Index 5	ID1							

Global Configuration: DP-34044-2, -3, -4									
Data Type		Bit 8	Bit 7	Bit 6	Bit 5	Bit 4	Bit 3	Bit 2	Bit 1
2 bit	Sub-Index 1	Spare		Spare		Spare		Control Mode Reset	
	Sub-Index 2	Spare		Sensor Power Control		Analog Raw Value		Enable 24V DC	
Byte	Sub-Index 3	Input/Output Mode							
	Sub-Index 4	ID1							

Global Configuration: DP-34044-5									
Data Type		Bit 8	Bit 7	Bit 6	Bit 5	Bit 4	Bit 3	Bit 2	Bit 1
2 bit	Sub-Index 1	Spare		Spare		Spare		Control Mode Reset	
	Sub-Index 2	Spare		Sensor Power Control		Analog Raw Value		Enable 24V DC	
Byte	Sub-Index 3	ID1							

NOTE: Data Panel uses little-endian bit ordering

Name	Applicable Variant	Description	Data Type	Access	Default Value
Control Mode Reset	ALL	Enables Controller Mode Output Reset	UNSIGNED8	RW	0x00
Sensor Power Control	DP-34044-1, -2	Enables discrete Sensor Power control (0=Default Sensor Power ON, 1=Discrete Control)			
	DP-34044-3, -4, -5	N/A			
Analog Raw Value	DP-34044-1, -2, -3, -4	Sets all analog to be read in raw value as opposed to scaled (.005668 V/bit)			
	DP-34044-5	N/A			
Enable 24V DC	ALL	Enables the low and over voltage fault limits for 24V DC system. Feeding 24V DC to 12V DC system would cause system over voltage error. This is also used for the output overcurrent and short circuit detection.			
Output Mode	DP-34044-1, -3, -4	Sets the global configuration of ALL the outputs, overrides 0x53h and 0x54h. Mode 0x0 = Not Used, 0x1 = Digital, 0x2 = Data (0-4,000), 0x3 = Percent (0-1,000 = 0-100.0%), 0x4 = Current (0-4,000 = 0-4.000A): cannot be used in this mode			0x01
	DP-34044-2, -5	N/A			
Input Mode	DP-34044-1, -2	Sets the global configuration of the inputs. Mode 0x0 = Mode 2 Not Used, 0x1 = Digital Positive, 0x2 = Digital Ground (Analog 3-7 cannot be used in global configuration mode)			
	DP-34044-3, -4, -5	N/A			
ID1	ALL	User defined byte for configuration ID, this will be transmitted in Index 5000:4	0x00		

Index 2001: DP-34044-1 ✓

I/O Configuration									
Data Type		Bit 8	Bit 7	Bit 6	Bit 5	Bit 4	Bit 3	Bit 2	Bit 1
Byte	Sub-Index 1	OUTMODE1B				OUTMODE1A			
4 bit	Sub-Index 2	OUTMODE2B				OUTMODE2A			
	Sub-Index 3	OUTMODE3B				OUTMODE3A			
	Sub-Index 4	OUTMODE4B				OUTMODE4A			
	Sub-Index 5	INMODE5B				INMODE5A			
	Sub-Index 6	INMODE6B				INMODE6A			
	Sub-Index 7	INMODE7B				INMODE7A			
	Sub-Index 8	INMODE8B				INMODE8A			

NOTE: Data Panel uses little-endian bit ordering

Name	Description	Data Type	Access	Default Value
OUTMODE1B	Mode 0x0 = Disabled, 0x1 = Digital, 0x2 = Data (0-4,000), 0x3 = Percent (0-1,000 = 0-100.0%), 0x4 = Current (0-4,000 = 0-4.000A)	UNSIGNED8	RW	0x11
OUTMODE1A				
OUTMODE2B				
OUTMODE2A				
OUTMODE3B				
OUTMODE3A				
OUTMODE4B				
OUTMODE4A				
INMODE5B	Mode 0x0 = Disabled, 0x1 = Digital Positive, 0x2 = Digital Ground, 0x3 = 4-20mA (4,000-20,000), 0x4 = 0-5V DC (0-5,000), 0x5 = 0-10V DC (0-10,000), 0x6 = 0-32V DC (0-32,000), 0x9 = Ratiometric (0-100.0% of P0 V DC)	UNSIGNED8	RW	0x11
INMODE6B				
INMODE7B				
INMODE8B				
INMODE5A	Mode 0x0 = Disabled, 0x1 = Digital Positive, 0x2 = Digital Ground	UNSIGNED8	RW	0x11
INMODE6A				
INMODE7A	Mode 0x0 = Disabled, 0x1 = Digital Positive, 0x2 = Digital Ground, 0x7 =Frequency, 0x8 =Counter, 0xA =Encoder	UNSIGNED8	RW	0x11
INMODE8A	Mode 0x0 = Disabled, 0x1 = Digital Positive, 0x2 = Digital Ground, 0x7 = Frequency, 0x8 =Counter			

NOTE: The Global Input/Output Configuration must be zero for individual configuration

NOTE: Mode 0x7h or 0x8h applies to INMODE7A and INMODE8A only

NOTE: Uses Mode 0x6h input range with percent measured battery data

NOTE: Mode 0xAh applies to INMODE7A only; INMODE8A is ignored

Index 2001: DP-34044-2 ✓

I/O Configuration									
Data Type		Bit 8	Bit 7	Bit 6	Bit 5	Bit 4	Bit 3	Bit 2	Bit 1
Byte	Sub-Index 1	INMODE1B				INMODE1A			
4 bit	Sub-Index 2	INMODE2B				INMODE2A			
	Sub-Index 3	INMODE3B				INMODE3A			
	Sub-Index 4	INMODE4B				INMODE4A			
	Sub-Index 5	INMODE5B				INMODE5A			
	Sub-Index 6	INMODE6B				INMODE6A			
	Sub-Index 7	INMODE7B				INMODE7A			
	Sub-Index 8	INMODE8B				INMODE8A			

NOTE: Data Panel uses little-endian bit ordering

Name	Description	Data Type	Access	Default Value
INMODE1B	Mode 0x0 = Disabled, 0x1 = Digital Positive, 0x2 = Digital Ground, 0x3 = 4-20mA (4,000-20,000), 0x4 = 0-5V DC (0-5,000), 0x5 = 0-10V DC (0-10,000), 0x6 = 0-32V DC (0-32,000), 0x9 = Ratiometric (0-100.0% of P0 V DC)	UNSIGNED8	RW	0x11
INMODE2B				
INMODE3B				
INMODE4B				
INMODE5B				
INMODE6B				
INMODE7B				
INMODE8B				
INMODE1A	Mode 0x0 = Disabled, 0x1 = Digital Positive, 0x2 = Digital Ground	UNSIGNED8	RW	0x11
INMODE2A				
INMODE3A				
INMODE4A				
INMODE5A				
INMODE6A				
INMODE7A	Mode 0x0 = Disabled, 0x1 = Digital Positive, 0x2 = Digital Ground, 0x7 = Frequency, 0x8 = Counter, 0xA = Encoder	UNSIGNED8	RW	0x11
INMODE8A				

NOTE: Mode 0x7h or 0x8h applies to INMODE7A and INMODE8A only

NOTE: Uses Mode 0x6h input range with percent measured battery data

NOTE: Mode 0xAh applies to INMODE7A only; INMODE8A is ignored

Index 2001: DP-34044-3 ✓

Output Configuration									
Data Type		Bit 8	Bit 7	Bit 6	Bit 5	Bit 4	Bit 3	Bit 2	Bit 1
Byte	Sub-Index 1	OUTMODE1B				OUTMODE1A			
4 bit	Sub-Index 2	OUTMODE2B				OUTMODE2A			
	Sub-Index 3	OUTMODE3B				OUTMODE3A			
	Sub-Index 4	OUTMODE4B				OUTMODE4A			
	Sub-Index 5	OUTMODE5B				OUTMODE5A			
	Sub-Index 6	OUTMODE6B				OUTMODE6A			
	Sub-Index 7	OUTMODE7B				OUTMODE7A			
	Sub-Index 8	OUTMODE8B				OUTMODE8A			

NOTE: Data Panel uses little-endian bit ordering

Name	Description	Data Type	Access	Default Value
OUTMODE1B	Mode 0x0 = Disabled, 0x1 = Digital, 0x2 = Data (0-4,000), 0x3 = Percent (0-1,000 = 0-100.0%), 0x4 = Current (0-4,000 = 0-4.000A)	UNSIGNED8	RW	0x11
OUTMODE1A	Mode 0x0 = Disabled, 0x1 = Digital			
OUTMODE2B	Mode 0x0 = Disabled, 0x1 = Digital, 0x2 = Data (0-4,000), 0x3 = Percent (0-1,000 = 0-100.0%), 0x4 = Current (0-4,000 = 0-4.000A)			
OUTMODE2A				
OUTMODE3B				
OUTMODE3A				
OUTMODE4B	Mode 0x0 = Disabled, 0x1 = Digital, 0x2 = Data (0-4,000) 0x3 = Percent (0-1,000 = 0-100.0%), 0x4 = Current (0-4,000 = 0-4.000A)			
OUTMODE4A				
OUTMODE5B				
OUTMODE5A				
OUTMODE6B				
OUTMODE6A				
OUTMODE7B				
OUTMODE7A				
OUTMODE8B				
OUTMODE8A				

NOTE: The Global Input/Output Configuration must be zero for individual configuration

Index 2001: DP-34044-4 ✓

Output Configuration									
Data Type		Bit 8	Bit 7	Bit 6	Bit 5	Bit 4	Bit 3	Bit 2	Bit 1
Byte	Sub-Index 1	OUTMODE1B				OUTMODE1A			
4 bit	Sub-Index 2	Spare				OUTMODE2B & OUTMODE2A			
	Sub-Index 3					OUTMODE3B & OUTMODE3A			
	Sub-Index 4					OUTMODE4B & OUTMODE4A			
	Sub-Index 5					OUTMODE5B & OUTMODE5A			
	Sub-Index 6					OUTMODE6B & OUTMODE6A			
	Sub-Index 7					OUTMODE7B & OUTMODE7A			
	Sub-Index 8					OUTMODE8B & OUTMODE8A			

NOTE: Data Panel uses little-endian bit ordering

Name	Description	Data Type	Access	Default Value
OUTMODE1B	Mode 0x0 = Disabled, 0x1 = Digital	UNSIGNED8	RW	0x11
OUTMODE1A				
OUTMODE2B & OUTMODE2A	Mode 0x0 = Disabled, 0x1 = Digital, 0x2 = Data (0-4,000), 0x3 = Percent (0-1,000 = 0-100.0%), 0x4 = Current (0-4,000 = 0-4.000A)			
OUTMODE3B & OUTMODE3A	Mode 0x0 = Disabled, 0x1 = Digital			
OUTMODE4B & OUTMODE4A	Mode 0x0 = Disabled, 0x1 = Digital, 0x2 = Data (0-4,000), 0x3 = Percent (0-1,000 = 0-100.0%), 0x4 = Current (0-4,000 = 0-4.000A)			
OUTMODE5B & OUTMODE5A				
OUTMODE6B & OUTMODE6A				
OUTMODE7B & OUTMODE7A				
OUTMODE8B & OUTMODE8A				

NOTE: The Global Input/Output Configuration must be zero for individual configuration

Index 2002: DP-34044-1, -3, -4 ✓

PWM(i) Configuration									
Data Type		Bit 8	Bit 7	Bit 6	Bit 5	Bit 4	Bit 3	Bit 2	Bit 1
Byte	Sub-Index 1	Port 1A Kp							
	Sub-Index 2	Port 1A Ki							
	Sub-Index 3	Port 1B Kp							
	Sub-Index 4	Port 1B Ki							
	Sub-Index 5	Port 2A Kp							
	Sub-Index 6	Port 2A Ki							
	Sub-Index 7	Port 2B Kp							
	Sub-Index 8	Port 2B Ki							
	Sub-Index 9	Port 3A Kp							
	Sub-Index 10	Port 3A Ki							
	Sub-Index 11	Port 3B Kp							
	Sub-Index 12	Port 3B Ki							
	Sub-Index 13	Port 4A Kp							
	Sub-Index 14	Port 4A Ki							
	Sub-Index 15	Port 4B Kp							
	Sub-Index 16	Port 4B Ki							
	Sub-Index 17	Port 5A Kp							
	Sub-Index 18	Port 5A Ki							
	Sub-Index 19	Port 5B Kp							
	Sub-Index 20	Port 5B Ki							
	Sub-Index 21	Port 6A Kp							
	Sub-Index 22	Port 6A Ki							
	Sub-Index 23	Port 6B Kp							
	Sub-Index 24	Port 6B Ki							
	Sub-Index 25	Port 7A Kp							
	Sub-Index 26	Port 7A Ki							
	Sub-Index 27	Port 7B Kp							
	Sub-Index 28	Port 7B Ki							
	Sub-Index 29	Port 8A Kp							
	Sub-Index 30	Port 8A Ki							
	Sub-Index 31	Port 8B Kp							
	Sub-Index 32	Port 8B Ki							

NOTE: Data Panel uses little-endian bit ordering

Applicable Sub-Indices	Applicable Variants	Description	Data Type	Access	Default Value
1, 3, 5, 7, 9, 11, 13, 15	DP-34044-1, -2	Output proportional set point (0-250 = 0-2.50, >250=0) default 100	UNSIGNED8	RW	0x64
2, 4, 6, 8, 10, 12, 14, 16		Output integral set point (0-250 = 0-2.50, >250=0) default 100			
3, 7, 9, 11, 13, 15	DP-34044-4	Output proportional set point (0-250 = 0-2.50, >250=0) default 100			
4, 8, 10, 12, 14, 16		Output integral set point (0-250 = 0-2.50, >250=0) default 100			
17, 19, 21, 23, 25, 27, 29, 31	DP-34044-3	Output proportional set point (0-250 = 0-2.50, >250=0) default 100			
18, 20, 22, 24, 26, 28, 30, 32		Output integral set point (0-250 = 0-2.50, >250=0) default 100			
1, 2, 5, 6	DP-34044-4	N/A	N/A		
17-32	DP-34044-1, -4				

Index 2003: DP-34044-1, -2

Counter Configuration									
Data Type		Bit 8	Bit 7	Bit 6	Bit 5	Bit 4	Bit 3	Bit 2	Bit 1
2 bit	Sub-Index 1	Counter 7A Enable Output 3A		Counter 7A Enable Overflow		Counter 7A Reset		Counter 7A On/Off	
	Sub-Index 2	Counter 8A Enable Output 4A		Counter 8A Enable Overflow		Counter 8A Reset		Counter 8A On/Off	

NOTE: Data Panel uses little-endian bit ordering

Name	Applicable Variant	Description
Counter 7A Enable Output 3A*	DP-34044-1, -2	Enable Output 3A when Counter 7A is enabled and set point hasn't been reached, 00 = Off, 01 = On (not used in encoder mode)
Counter 7A Enable Overflow		Enable Counter 7A Overflow, count continues after setpoint is achieved, 00 = Off, 01 = On (not used in encoder mode)
Counter 7A Reset		Reset Counter 7A, 00 = Off, 01 = On (used in encoder mode)
Counter 7A On/Off		Enable Counter 7A, 00 = Off, 01 = On (used in encoder mode)
Counter 8A Enable Output 4A**		Enable Output 3A when Counter 7A is enabled and setpoint hasn't been reached, 00 = Off, 01 = On (not used in encoder mode)
Counter 8A Enable Overflow		Enable Counter 7A Overflow, count continues after setpoint is achieved, 00 = Off, 01 = On (not used in encoder mode)
Counter 8A Reset		Reset Counter 7A, 00 = Off, 01 = On (used in encoder mode)
Counter 8A On/Off		Enable Counter 7A, 00 = Off, 01 = On (used in encoder mode)

Index 2004: DP-34044-3, -4, -5 ✓

10A Limit Configuration									
Data Type		Bit 8	Bit 7	Bit 6	Bit 5	Bit 4	Bit 3	Bit 2	Bit 1
Byte	Sub-Index 1	Port 1A							
	Sub-Index 2	Port 3A							

NOTE: Data Panel uses little-endian bit ordering

Name	Description	Data Type	Access	Default Value
Port 1A	Set amp range 0.0-10.0A = Data Range 0-100	UNSIGNED8	RW	0x64
Port 3A				

Index 2005: DP-34044-4

Module Direction Configuration									
Data Type		Bit 8	Bit 7	Bit 6	Bit 5	Bit 4	Bit 3	Bit 2	Bit 1
1 bit	Sub-Index 1	Direction Port 8	Direction Port 7	Direction Port 6	Direction Port 5	Direction Port 4	Direction Port 3	Direction Port 2	Direction Port 1

NOTE: Data Panel uses little-endian bit ordering

Name	Description	Data Type	Access	Default Value
Direction Port 1	Not Used	UNSIGNED8	RW	0x00
Direction Port 2	0 = Port 2A, 1 = Port 2B			
Direction Port 3	Not Used			
Direction Port 4	0 = Port 4A, 1 = Port 4B			
Direction Port 5	0 = Port 5A, 1 = Port 5B			
Direction Port 6	0 = Port 6A, 1 = Port 6B			
Direction Port 7	0 = Port 7A, 1 = Port 7B			
Direction Port 8	0 = Port 8A, 1 = Port 8B			

Index 3000: DP-34044-1, -3, -4 ✓

Frequency									
Data Type		Bit 8	Bit 7	Bit 6	Bit 5	Bit 4	Bit 3	Bit 2	Bit 1
Word	Sub-Index 1	Frequency							
	Sub-Index 2	Spare				Frequency			

NOTE: Data Panel uses little-endian bit ordering

Name	Description	Data Type	Access	Default Value
Frequency	Sets the configuration of the frequency for all channels (30-1140 Hz)	UNSIGNED16	RW	0x41

Index 3001: DP-34044-1

Setpoint									
Data Type		Bit 8	Bit 7	Bit 6	Bit 5	Bit 4	Bit 3	Bit 2	Bit 1
Word	Sub-Index 1	Counter 7A Setpoint							
	Sub-Index 2	Spare				Counter 8A Setpoint			
	Sub-Index 3	Counter 8A Setpoint							
	Sub-Index 4	Spare				Counter 8A Setpoint			

NOTE: Data Panel uses little-endian bit ordering

Name	Description	Data Type	Access	Default Value
Counter 7A Setpoint	Setpoint for count	UNSIGNED16	RW	0x0000
Counter 8A Setpoint				

Index 2005: DP-34044-2

Setpoint									
Data Type		Bit 8	Bit 7	Bit 6	Bit 5	Bit 4	Bit 3	Bit 2	Bit 1
Word	Sub-Index 1	Counter 7A Setpoint							
	Sub-Index 2	Spare				Counter 8A Setpoint			
	Sub-Index 3	Counter 8A Setpoint							
	Sub-Index 4	Spare				Counter 8A Setpoint			

NOTE: Data Panel uses little-endian bit ordering

Name	Description	Data Type	Access	Default Value
Counter 7A Setpoint	Setpoint for count	UNSIGNED16	RW	0x0000
Counter 8A Setpoint				

Index 5000: All Variants

Response Message									
Data Type		Bit 8	Bit 7	Bit 6	Bit 5	Bit 4	Bit 3	Bit 2	Bit 1
2 bit	Sub-Index 1	Status 4		Status 3		Status 2		Status 1	
	Sub-Index 2	Status 8		Status 7		Status 6		Status 5	
Byte	Sub-Index 3	Fault Code							
	Sub-Index 4	User ID							

NOTE: Data Panel uses little-endian bit ordering

Name	Applicable Variant	Description	Data Type	Access	Default Value
Status 4	ALL	Node Alive	UNSIGNED8	RO	0x00
Status 3		Alternate Configuration Received			
Status 2		Configuration Saved (module is configured)			
Status 1		Factory Default Configuration			
Status 8		Not Used			
Status 7					
Status 6		Fault count not zero			
Status 5		Node fault present			
Fault Code		Active fault code			
User ID		The User ID of the module (Configured in Index 2000)			

Index 5001: DP-34044-1

Output Status Message (DPLF1)									
Data Type		Bit 8	Bit 7	Bit 6	Bit 5	Bit 4	Bit 3	Bit 2	Bit 1
2 bit	Sub-Index 1	Configuration Pair 4		Configuration Pair 3		Configuration Pair 2		Configuration Pair 1	
	Sub-Index 2	Spare		Spare		Spare		Configuration Pair 5	
	Sub-Index 3	Output Status 2B		Output Status 2A		Output Status 1B		Output Status 1A	
	Sub-Index 4	Output Status 4B		Output Status 4A		Output Status 3B		Output Status 3A	
	Sub-Index 5	Spare		Input Port 6		Spare		Input Port 5	
	Sub-Index 6	Spare		Input Port 8		Spare		Input Port 7	
	Sub-Index 7	Spare		Spare		Power Bus P2		Power Bus P1	
Byte	Sub-Index 8	Save Configuration Counter							

NOTE: Data Panel uses little-endian bit ordering

Name	Description	Data Type	Access	Default Value
Configuration Pair 4	Node ID 3's configuration jumper is applied	UNSIGNED8	RO	0x00
Configuration Pair 3	Node ID 2's configuration jumper is applied			
Configuration Pair 2	Node ID 1's configuration jumper is applied			
Configuration Pair 1	Baud rate configuration jumper is applied			
Configuration Pair 5	Node ID 4's configuration jumper is applied			
Output Status 2B	Status of output, (00 = off), (01 = on), (10 = fault)			
Output Status 2A				
Output Status 1B				
Output Status 1A				
Output Status 4B				
Output Status 4A				
Output Status 3B				
Output Status 3A				
Input Port 6				
Input Port 5				
Input Port 8				
Input Port 7				
Power Bus P2	Status of Power Bus, (00 = off), (01 = on), (10 = fault)			
Power Bus P1	Status of Power Bus, (00 = off), (01 = on), (10 = fault)			
Save Configuration Counter	Count of how many times the configuration has been saved to the module			

Index 5001: DP-34044-2

Input Power Status Message (DPLF1)									
Data Type		Bit 8	Bit 7	Bit 6	Bit 5	Bit 4	Bit 3	Bit 2	Bit 1
2 bit	Sub-Index 1	Configuration Pair 4		Configuration Pair 3		Configuration Pair 2		Configuration Pair 1	
	Sub-Index 2	Spare		Spare		Spare		Configuration Pair 5	
	Sub-Index 3	Spare		Input Power Port 2		Spare		Input Power Port 1	
	Sub-Index 4	Spare		Input Power Port 4		Spare		Input Power Port 3	
	Sub-Index 5	Spare		Input Power Port 6		Spare		Input Power Port 5	
	Sub-Index 6	Spare		Input Power Port 8		Spare		Input Power Port 7	
	Sub-Index 7	Spare		Spare		Spare		Spare	
Byte	Sub-Index 8	Save Configuration Counter							

NOTE: Data Panel uses little-endian bit ordering

Name	Description	Data Type	Access	Default Value
Configuration Pair 4	Node ID 3's configuration jumper is applied	UNSIGNED8	RO	0x00
Configuration Pair 3	Node ID 2's configuration jumper is applied			
Configuration Pair 2	Node ID 1's configuration jumper is applied			
Configuration Pair 1	Baud rate configuration jumper is applied			
Configuration Pair 5	Node ID 4's configuration jumper is applied			
Input Power Port 2	Status of Input Power, (00 = off), (01 = on), (10 = fault)			
Input Power Port 1				
Input Power Port 4				
Input Power Port 3				
Input Power Port 6				
Input Power Port 5				
Input Power Port 8				
Input Power Port 7				
Save Configuration Counter	Count of how many times the configuration has been saved to the module			

Index 5001: DP-34044-3, -4, -5

Output Status Message (DPLF1)									
Data Type		Bit 8	Bit 7	Bit 6	Bit 5	Bit 4	Bit 3	Bit 2	Bit 1
2 bit	Sub-Index 1	Configuration Pair 4		Configuration Pair 3		Configuration Pair 2		Configuration Pair 1	
	Sub-Index 2	Spare		Spare		Spare		Configuration Pair 5	
	Sub-Index 3	Output Status 2B		Output Status 2A		Output Status 1B		Output Status 1A	
	Sub-Index 4	Output Status 4B		Output Status 4A		Output Status 3B		Output Status 3A	
	Sub-Index 5	Output Status 6B		Output Status 6A		Output Status 5B		Output Status 5A	
	Sub-Index 6	Output Status 8B		Output Status 8A		Output Status 7B		Output Status 7A	
	Sub-Index 7	Power Bus P4		Power Bus P3		Power Bus P2		Power Bus P1	
Byte	Sub-Index 8	Save Configuration Counter							

NOTE: Data Panel uses little-endian bit ordering

Name	Applicable Variant	Description	Data Type	Access	Default Value
Configuration Pair 4	DP-34044-3, -4, -5	Node ID 3's configuration jumper is applied	UNSIGNED8	RO	0x00
Configuration Pair 3		Node ID 2's configuration jumper is applied			
Configuration Pair 2		Node ID 1's configuration jumper is applied			
Configuration Pair 1		Baud rate configuration jumper is applied			
Configuration Pair 5		Node ID 4's configuration jumper is applied			
Output Status 2B		Status of output, (00 = off), (01 = on), (10 = fault)			
Output Status 2A					
Output Status 1B					
Output Status 1A					
Output Status 4B					
Output Status 4A					
Output Status 3B					
Output Status 3A					
Output Status 6B					
Output Status 6A					
Output Status 5B					
Output Status 5A					
Output Status 8B					
Output Status 8A					
Output Status 7B					
Output Status 7A					
Power Bus P4	DP-34044-3, -4	Status of Power Bus, (00 = off), (01 = on), (10 = fault)			
	DP-34044-5	N/A			
Power Bus P3	DP-34044-3, -4	Status of Power Bus, (00 = off), (01 = on), (10 = fault)			
	DP-34044-5	N/A			
Power Bus P2	DP-34044-3, -4	Status of Power Bus, (00 = off), (01 = on), (10 = fault)			
	DP-34044-5	N/A			
Power Bus P1	DP-34044-3, -4, -5	Status of Power Bus, (00 = off), (01 = on), (10 = fault)			
Save Configuration Counter		Count of how many times the configuration has been saved to the module			

Index 5002: All Variants

Device Information (DPLF2)									
Data Type		Bit 8	Bit 7	Bit 6	Bit 5	Bit 4	Bit 3	Bit 2	Bit 1
10 bit	Sub-Index 1	VBAT							
	Sub-Index 2	Spare						VBAT	
Word	Sub-Index 3	TEMP							
	Sub-Index 4	Spare				TEMP			
	Sub-Index 5	CNFG1							
	Sub-Index 6	Spare				CNFG1			
	Sub-Index 7	CNFG2							
	Sub-Index 8	Spare				CNFG2			
	Sub-Index 9	CNFG3							
	Sub-Index 10	Spare				CNFG3			

NOTE: Data Panel uses little-endian bit ordering

Name	Applicable Variant	Description	Data Type	Access	Default Value
VBAT	ALL	Battery Voltage 100mV/bit, data range 0 - 320 (32.0V DC max).	UNSIGNED16	RO	0x00
TEMP		Module Temperature , -100.0°F to +300.0°F, data range 0 – 4000 bits.			
CNFG1		Hardware Configuration			
CNFG2		PCB Assembly Revision			
CNFG3		Additional Configuration			

Index 5003: DP-34044-1, -3

Status Message Amp									
Data Type		Bit 8	Bit 7	Bit 6	Bit 5	Bit 4	Bit 3	Bit 2	Bit 1
Word	Sub-Index 1	Output 1A Amp Feedback							
	Sub-Index 2	Spare				Output 1A Amp Feedback			
	Sub-Index 3	Output 1B Amp Feedback							
	Sub-Index 4	Spare				Output 1B Amp Feedback			
	Sub-Index 5	Output 2A Amp Feedback							
	Sub-Index 6	Spare				Output 2A Amp Feedback			
	Sub-Index 7	Output 2B Amp Feedback							
	Sub-Index 8	Spare				Output 2B Amp Feedback			
	Sub-Index 9	Output 3A Amp Feedback							
	Sub-Index 10	Spare				Output 3A Amp Feedback			
	Sub-Index 11	Output 3B Amp Feedback							
	Sub-Index 12	Spare				Output 3B Amp Feedback			
	Sub-Index 13	Output 4A Amp Feedback							
	Sub-Index 14	Spare				Output 4A Amp Feedback			
	Sub-Index 15	Output 4B Amp Feedback							
	Sub-Index 16	Spare				Output 4B Amp Feedback			
	Sub-Index 17	Output 5A Amp Feedback							
	Sub-Index 18	Spare				Output 5A Amp Feedback			
	Sub-Index 19	Output 5B Amp Feedback							
	Sub-Index 20	Spare				Output 5B Amp Feedback			
	Sub-Index 21	Output 6A Amp Feedback							
	Sub-Index 22	Spare				Output 6A Amp Feedback			
	Sub-Index 23	Output 6B Amp Feedback							
	Sub-Index 24	Spare				Output 6B Amp Feedback			
	Sub-Index 25	Output 7A Amp Feedback							
	Sub-Index 26	Spare				Output 7A Amp Feedback			
	Sub-Index 27	Output 7B Amp Feedback							
	Sub-Index 28	Spare				Output 7B Amp Feedback			
	Sub-Index 29	Output 8A Amp Feedback							
	Sub-Index 30	Spare				Output 8A Amp Feedback			
	Sub-Index 31	Output 8B Amp Feedback							
	Sub-Index 32	Spare				Output 8B Amp Feedback			

NOTE: Data Panel uses little-endian bit ordering

Applicable Sub-Indices	Applicable Variant	Description	Data Type	Access	Default Value
1-16	DP-34044-1, -3	Current reading on output port, 0-4,000 = 0-4000 mA	UNSIGNED16	RO	0x0000
17-32	DP-34044-3				
	DP-34044-1	N/A			

Index 5003: DP-34044-4

		Status Message Amp							
Data Type		Bit 8	Bit 7	Bit 6	Bit 5	Bit 4	Bit 3	Bit 2	Bit 1
Word	Sub-Index 1	Output 1 Amp Feedback							
	Sub-Index 2	Spare				Output 1 Amp Feedback			
	Sub-Index 3	Output 2 Amp Feedback							
	Sub-Index 4	Spare				Output 2 Amp Feedback			
	Sub-Index 5	Output 3 Amp Feedback							
	Sub-Index 6	Spare				Output 3 Amp Feedback			
	Sub-Index 7	Output 4 Amp Feedback							
	Sub-Index 8	Spare				Output 4 Amp Feedback			
	Sub-Index 9	Output 5 Amp Feedback							
	Sub-Index 10	Spare				Output 5 Amp Feedback			
	Sub-Index 11	Output 6 Amp Feedback							
	Sub-Index 12	Spare				Output 6 Amp Feedback			
	Sub-Index 13	Output 7 Amp Feedback							
	Sub-Index 14	Spare				Output 7 Amp Feedback			
	Sub-Index 15	Output 8 Amp Feedback							
	Sub-Index 16	Spare				Output 8 Amp Feedback			
	Sub-Index 17	Output 1A Amp Feedback							
	Sub-Index 18	Spare				Output 1A Amp Feedback			
	Sub-Index 19	Output 1B Amp Feedback							
	Sub-Index 20	Spare				Output 1B Amp Feedback			
	Sub-Index 21	Output 3A Amp Feedback							
	Sub-Index 22	Spare				Output 3A Amp Feedback			
	Sub-Index 23	Output 3B Amp Feedback							
	Sub-Index 24	Spare				Output 3B Amp Feedback			

NOTE: Data Panel uses little-endian bit ordering

Applicable Sub-Indices	Description	Data Type	Access	Default Value
ALL	Current reading on output port, 0-4,000 = 0-4000 mA	UNSIGNED16	RO	0x0000

Index 5003: DP-34044-5

Status Message Amp									
Data Type		Bit 8	Bit 7	Bit 6	Bit 5	Bit 4	Bit 3	Bit 2	Bit 1
Byte	Sub-Index 1	Output 1A Amp Feedback							
	Sub-Index 2	Output 1B Amp Feedback							
	Sub-Index 3	Output 2A Amp Feedback							
	Sub-Index 4	Output 2B Amp Feedback							
	Sub-Index 5	Output 3A Amp Feedback							
	Sub-Index 6	Output 3B Amp Feedback							
	Sub-Index 7	Output 4A Amp Feedback							
	Sub-Index 8	Output 4B Amp Feedback							
	Sub-Index 9	Output 5A Amp Feedback							
	Sub-Index 10	Output 5B Amp Feedback							
	Sub-Index 11	Output 6A Amp Feedback							
	Sub-Index 12	Output 6B Amp Feedback							
	Sub-Index 13	Output 7A Amp Feedback							
	Sub-Index 14	Output 7B Amp Feedback							
	Sub-Index 15	Output 8A Amp Feedback							
	Sub-Index 16	Output 8B Amp Feedback							

NOTE: Data Panel uses little-endian bit ordering

Applicable Sub-Indices	Description	Data Type	Access	Default Value
1, 5	Current reading on output port, 0-100=0-10A, data range 0 - 220 bits (22.0 Amp)	UNSIGNED8	RW	0x00
2, 3, 4, 6-16	Current reading on output port, 0-40=0-4A, data range 0 - 220 bits (22.0 Amp)			

Index 5004: All Variants

Fault Count Message									
Data Type		Bit 8	Bit 7	Bit 6	Bit 5	Bit 4	Bit 3	Bit 2	Bit 1
Byte	Sub-Index 1	Fault Counter F1							
	Sub-Index 2	Fault Counter F2							
	Sub-Index 3	Fault Counter F3							
	Sub-Index 4	Fault Counter F4							
	Sub-Index 5	Fault Counter F5							
	Sub-Index 6	Fault Counter F6							
	Sub-Index 7	Fault Counter F7							
	Sub-Index 8	Fault Counter F8							

NOTE: Data Panel uses little-endian bit ordering

Data Type	Access	Default Value
UNSIGNED8	RO	0x00

DEVICE PROFILE SEGMENT

Index 6000: DP-34044-1, -2

Read Input 8-bit: DP-34044-1									
Data Type		Bit 8	Bit 7	Bit 6	Bit 5	Bit 4	Bit 3	Bit 2	Bit 1
	Sub-Index 1	Input 8B	Input 8A	Input 7B	Input 7A	Input 6B	Input 6A	Input 5B	Input 5A

Read Input 8-bit: DP-34044-2									
Data Type		Bit 8	Bit 7	Bit 6	Bit 5	Bit 4	Bit 3	Bit 2	Bit 1
Byte	Sub-Index 1	Input 4B	Input 4A	Input 3B	Input 3A	Input 2B	Input 2A	Input 1B	Input 1A
	Sub-Index 2	Input 8B	Input 8A	Input 7B	Input 7A	Input 6B	Input 6A	Input 5B	Input 5A

NOTE: Data Panel uses little-endian bit ordering

Name	Applicable Variant	Description	Data Type	Access	Default Value
Input 4B	DP-34044-2	00 = Off, 01 = On, 10 = Fault	UNSIGNED8	RO	0x00
Input 4A					
Input 3B					
Input 3A					
Input 2B					
Input 2A					
Input 1B					
Input 1A					
Input 8B	DP-34044-1, -2				
Input 8A					
Input 7B					
Input 7A					
Input 6B					
Input 6A					
Input 5B					
Input 5A					

Index 6200: All Variants

Write Outputs 8-bit									
Data Type		Bit 8	Bit 7	Bit 6	Bit 5	Bit 4	Bit 3	Bit 2	Bit 1
1 bit	Sub-Index 1	Output 4B	Output 4A	Output 3B	Output 3A	Output 2B	Output 2A	Output 1B	Output 1A
	Sub-Index 2	Output 8B	Output 8A	Output 7B	Output 7A	Output 6B	Output 6A	Output 5B	Output 5A
	Sub-Index 3	Input Power Port 8	Input Power Port 7	Input Power Port 6	Input Power Port 5	Input Power Port 4	Input Power Port 3	Input Power Port 2	Input Power Port 1

NOTE: Data Panel uses little-endian bit ordering

Name	Applicable Variant	Description	Data Type	Access	Default Value
Output 4B	DP-34044-1, -3, -4, -5	Turns the output on when in Digital Mode (not used when using any other mode)	UNSIGNED8	RWW	0x00
Output 4A					
Output 3B					
Output 3A					
Output 2B					
Output 2A					
Output 1B					
Output 1A					
Output 8B	DP-34044-3, -4, -5				
Output 8A					
Output 7B					
Output 7A					
Output 6B					
Output 6A					
Output 5B					
Output 5A					
Input Power Port 8	DP-34044-1, -2				
Input Power Port 7					
Input Power Port 6					
Input Power Port 5					
Input Power Port 4	DP-34044-2				
Input Power Port 3					
Input Power Port 2					
Input Power Port 1					
Byte 2	DP-34044-1	N/A			
Bytes 1 & 2	DP-34044-2				
Byte 3	DP-34044-3, -4, -5				

Index 6401: DP-34044-1

Read Analog Input 16-bit									
Data Type		Bit 8	Bit 7	Bit 6	Bit 5	Bit 4	Bit 3	Bit 2	Bit 1
	Sub-Index 1	Analog Input 5A							
	Sub-Index 2	Spare				Analog Input 5A			
	Sub-Index 3	Analog Input 5B							
	Sub-Index 4	Spare				Analog Input 5B			
	Sub-Index 5	Analog Input 6A							
	Sub-Index 6	Spare				Analog Input 6A			
	Sub-Index 7	Analog Input 6B							
	Sub-Index 8	Spare				Analog Input 6B			
	Sub-Index 9	Analog Input 7A							
	Sub-Index 10	Spare				Analog Input 7A			
	Sub-Index 11	Analog Input 7B							
	Sub-Index 12	Spare				Analog Input 7B			
	Sub-Index 13	Analog Input 8A							
	Sub-Index 14	Spare				Analog Input 8A			
	Sub-Index 15	Analog Input 8B							
	Sub-Index 16	Spare				Analog Input 8B			
	Sub-Index 17	Hertz_Count Input 7A							
	Sub-Index 18	Spare				Hertz_Count Input 7A			
	Sub-Index 19	Duty Cycle_SP Input 7A							
	Sub-Index 20	Spare				Duty Cycle_SP Input 7A			
	Sub-Index 21	Hertz_Count Input 8A							
	Sub-Index 22	Spare				Hertz_Count Input 8A			
	Sub-Index 23	Duty Cycle_SP Input 8A							
	Sub-Index 24	Spare				Duty Cycle_SP Input 8A			

NOTE: Data Panel uses little-endian bit ordering

Name	Description	Data Type	Access	Default Value
Analog Input 5A	Not used on this module, discrete only	INTEGER16	RO	0x0000
Analog Input 6A				
Analog Input 7A				
Analog Input 8A				
Analog Input 5B	Mode 0x3= 4-20mA (4,000-20,000), 0x4= 0-5V DC (0-5,000), 0x5= 0-10V DC (0-10,000), 0x6= 0-32V DC (0-32,000), 0x9= Ratiometric (0-100.0% of P0 V DC)			
Analog Input 6B				
Analog Input 7B				
Analog Input 8B				
Hertz_Count Input 7A	Hertz is used when the input is configured as a frequency input Count is used when the input is configured as a high speed counter			
Hertz_Count Input 8A				
Duty Cycle_SP Input 7A	Duty Cycle is used when the input is configured as a frequency input Setpoint is used when the input is configured as a high speed counter			
Duty Cycle_SP Input 8A				

Index 6401: DP-34044-2

Read Analog Input 16-bit									
Data Type		Bit 8	Bit 7	Bit 6	Bit 5	Bit 4	Bit 3	Bit 2	Bit 1
Word	Sub-Index 1	Analog Input 1A							
	Sub-Index 2	Spare				Analog Input 1A			
	Sub-Index 3	Analog Input 1B							
	Sub-Index 4	Spare				Analog Input 1B			
	Sub-Index 5	Analog Input 2A							
	Sub-Index 6	Spare				Analog Input 2A			
	Sub-Index 7	Analog Input 2B							
	Sub-Index 8	Spare				Analog Input 2B			
	Sub-Index 9	Analog Input 3A							
	Sub-Index 10	Spare				Analog Input 3A			
	Sub-Index 11	Analog Input 3B							
	Sub-Index 12	Spare				Analog Input 3B			
	Sub-Index 13	Analog Input 4A							
	Sub-Index 14	Spare				Analog Input 4A			
	Sub-Index 15	Analog Input 4B							
	Sub-Index 16	Spare				Analog Input 4B			
	Sub-Index 17	Analog Input 5A							
	Sub-Index 18	Spare				Analog Input 5A			
	Sub-Index 19	Analog Input 5B							
	Sub-Index 20	Spare				Analog Input 5B			
	Sub-Index 21	Analog Input 6A							
	Sub-Index 22	Spare				Analog Input 6A			
	Sub-Index 23	Analog Input 6B							
	Sub-Index 24	Spare				Analog Input 6B			
	Sub-Index 25	Analog Input 7A							
	Sub-Index 26	Spare				Analog Input 7A			
	Sub-Index 27	Analog Input 7B							
	Sub-Index 28	Spare				Analog Input 7B			
	Sub-Index 29	Analog Input 8A							
	Sub-Index 30	Spare				Analog Input 8A			
	Sub-Index 31	Analog Input 8B							
	Sub-Index 32	Spare				Analog Input 8B			
	Sub-Index 33	Hertz_Count Input 7A							
	Sub-Index 34	Spare				Hertz_Count Input 7A			
	Sub-Index 35	Duty Cycle_SP Input 7A							
	Sub-Index 36	Spare				Duty Cycle_SP Input 7A			
	Sub-Index 37	Hertz_Count Input 8A							
	Sub-Index 38	Spare				Hertz_Count Input 8A			
	Sub-Index 39	Duty Cycle_SP Input 8A							
	Sub-Index 40	Spare				Duty Cycle_SP Input 8A			

NOTE: Data Panel uses little-endian bit ordering

Index 6401: DP-34044-2 (continued)

Name	Description	Data Type	Access	Default Value
Analog Input 1A	Not used on this module, discrete only	INTEGER16	RO	0x0000
Analog Input 2A				
Analog Input 3A				
Analog Input 4A				
Analog Input 5A				
Analog Input 6A				
Analog Input 7A				
Analog Input 8A				
Analog Input 1B	Mode 0x3= 4-20mA (4,000-20,000), 0x4= 0-5V DC (0-5,000), 0x5= 0-10V DC (0-10,000), 0x6= 0-32V DC (0-32,000), 0x9= Ratiometric (0-100.0% of P0 V DC)	INTEGER16	RO	0x0000
Analog Input 2B				
Analog Input 3B				
Analog Input 4B				
Analog Input 5B				
Analog Input 6B				
Analog Input 7B				
Analog Input 8B				
Hertz_Count Input 7A	Hertz is used when the input is configured as a frequency input Count is used when the input is configured as a high speed counter	INTEGER16	RO	0x0000
Hertz_Count Input 8A				
Duty Cycle_SP Input 7A	Duty Cycle is used when the input is configured as a frequency input Setpoint is used when the input is configured as a high speed counter	INTEGER16	RO	0x0000
Duty Cycle_SP Input 8A				

INMODE#	Output Operation	Notes
0x3h	Analog 4-20 mAmp	0-20000
0x4h	Analog 0-5 Vdc	0-5000
0x5h	Analog 0-10 Vdc	0-10000
0x6h	Analog 0-32 Vdc	0-32000
0x9h	Ratiometric Input 100.0%	0-1000

	FREQUENCY MODE	COUNTER MODE	ENCODER MODE
FREQ_1	Hz Input7A	Count 7A	LSB: Byte 1
FREQ_2	DUTY Input7A	Set Point 7A	MSB: Byte 4
FREQ_3	Hz Input8A	Count 8A	0x0000h
FREQ_4	DUTY Input8A	Set Point 8A	0x0000h

Index 6411: DP-34044-1, -3

Write Analog Output 16-bit									
Data Type		Bit 8	Bit 7	Bit 6	Bit 5	Bit 4	Bit 3	Bit 2	Bit 1
Word	Sub-Index 1	PWM Control Output 1A							
	Sub-Index 2	Spare				PWM Control Output 1A			
	Sub-Index 3	PWM Control Output 1B							
	Sub-Index 4	Spare				PWM Control Output 1B			
	Sub-Index 5	PWM Control Output 2A							
	Sub-Index 6	Spare				PWM Control Output 2A			
	Sub-Index 7	PWM Control Output 2B							
	Sub-Index 8	Spare				PWM Control Output 2B			
	Sub-Index 9	PWM Control Output 3A							
	Sub-Index 10	Spare				PWM Control Output 3A			
	Sub-Index 11	PWM Control Output 3B							
	Sub-Index 12	Spare				PWM Control Output 3B			
	Sub-Index 13	PWM Control Output 4A							
	Sub-Index 14	Spare				PWM Control Output 4A			
	Sub-Index 15	PWM Control Output 4B							
	Sub-Index 16	Spare				PWM Control Output 4B			
	Sub-Index 17	PWM Control Output 5A							
	Sub-Index 18	Spare				PWM Control Output 5A			
	Sub-Index 19	PWM Control Output 5B							
	Sub-Index 20	Spare				PWM Control Output 5B			
	Sub-Index 21	PWM Control Output 6A							
	Sub-Index 22	Spare				PWM Control Output 6A			
	Sub-Index 23	PWM Control Output 6B							
	Sub-Index 24	Spare				PWM Control Output 6B			
	Sub-Index 25	PWM Control Output 7A							
	Sub-Index 26	Spare				PWM Control Output 7A			
	Sub-Index 27	PWM Control Output 7B							
	Sub-Index 28	Spare				PWM Control Output 7B			
	Sub-Index 29	PWM Control Output 8A							
	Sub-Index 30	Spare				PWM Control Output 8A			
	Sub-Index 31	PWM Control Output 8B							
	Sub-Index 32	Spare				PWM Control Output 8B			

NOTE: Data Panel uses little-endian bit ordering

Applicable Sub-Indices	Applicable Variant	Description	Data Type	Access	Default Value
1-16	DP-34044-1, -3	Each 16 bit word use the lower 12 bits for control data for PWM and PWM(i) modes of the 4 Amp outputs. The data is either a decimal number from 0 – 1000 for percent mode in 10ths or 0-4000 for data mode in bits or current control mode in mAmp.	INTEGER16	RWW	0x0000
17-32	DP-34044-3				
	DP-34044-1				

Index 6411: DP-34044-4

Write Analog Output 16-bit									
Data Type		Bit 8	Bit 7	Bit 6	Bit 5	Bit 4	Bit 3	Bit 2	Bit 1
Word	Sub-Index 1	PWM Control Port 1							
	Sub-Index 2	Spare				PWM Control Port 1			
	Sub-Index 3	PWM Control Port 2							
	Sub-Index 4	Spare				PWM Control Port 2			
	Sub-Index 5	PWM Control Port 3							
	Sub-Index 6	Spare				PWM Control Port 3			
	Sub-Index 7	PWM Control Port 4							
	Sub-Index 8	Spare				PWM Control Port 4			
	Sub-Index 9	PWM Control Port 5							
	Sub-Index 10	Spare				PWM Control Port 5			
	Sub-Index 11	PWM Control Port 6							
	Sub-Index 12	Spare				PWM Control Port 6			
	Sub-Index 13	PWM Control Port 7							
	Sub-Index 14	Spare				PWM Control Port 7			
	Sub-Index 15	PWM Control Port 8							
	Sub-Index 16	Spare				PWM Control Port 8			

NOTE: Data Panel uses little-endian bit ordering

Applicable Sub-Indices	Description	Data Type	Access	Default Value
ALL	Each 16 bit word use the lower 12 bits for control data for PWM and PWM(i) modes of the 4 Amp outputs. The data is either a decimal number from 0 – 1000 for percent mode in 10ths or 0-4000 for data mode in bits or current control mode in mAmp.	INTEGER16	RWW	0x0000

Index 6423: DP-34044-1, -2 ✓

Analog Input Global Interrupt Enable									
Data Type		Bit 8	Bit 7	Bit 6	Bit 5	Bit 4	Bit 3	Bit 2	Bit 1
1 bit	Sub-Index 1	Spare	Spare	Spare	Spare	Spare	Spare	Spare	Interrupt Enable

NOTE: Data Panel uses little-endian bit ordering

Name	Applicable Variant	Description	Data Type	Access	Default Value
Interrupt Enable	DP-34044-1, -2	Each 16 bit word use the lower 12 bits for control data for PWM and PWM(i) modes of the 4 Amp outputs. The data is either a decimal number from 0 – 1000 for percent mode in 10ths or 0-4000 for data mode in bits or current control mode in mAmp.	BOOLEAN	RW	0x01

Index 6426: DP-34044-1, -2 ✓

Analog Input Interrupt Delta: DP-34044-1									
Data Type		Bit 8	Bit 7	Bit 6	Bit 5	Bit 4	Bit 3	Bit 2	Bit 1
Byte	Sub-Index 1	Port 5A							
	Sub-Index 2	Port 5B							
	Sub-Index 3	Port 6A							
	Sub-Index 4	Port 6B							
	Sub-Index 5	Port 7A							
	Sub-Index 6	Port 7B							
	Sub-Index 7	Port 8A							
	Sub-Index 8	Port 8B							
	Sub-Index 9	FREQ 1							
	Sub-Index 10	FREQ 2							
	Sub-Index 11	FREQ 3							
	Sub-Index 12	FREQ 4							

Analog Input Interrupt Delta: DP-34044-2									
Data Type		Bit 8	Bit 7	Bit 6	Bit 5	Bit 4	Bit 3	Bit 2	Bit 1
Byte	Sub-Index 1	Port 1A							
	Sub-Index 2	Port 1B							
	Sub-Index 3	Port 2A							
	Sub-Index 4	Port 2B							
	Sub-Index 5	Port 3A							
	Sub-Index 6	Port 3B							
	Sub-Index 7	Port 4A							
	Sub-Index 8	Port 4B							
	Sub-Index 9	Port 5A							
	Sub-Index 10	Port 5B							
	Sub-Index 11	Port 6A							
	Sub-Index 12	Port 6B							
	Sub-Index 13	Port 7A							
	Sub-Index 14	Port 7B							
	Sub-Index 15	Port 8A							
	Sub-Index 16	Port 8B							
	Sub-Index 17	FREQ 1							
	Sub-Index 18	FREQ 2							
	Sub-Index 19	FREQ 3							
	Sub-Index 20	FREQ 4							

NOTE: Data Panel uses little-endian bit ordering

Index 6426: DP-34044-1, -2 (continued)

Name	Applicable Variants	Description	Data Type	Access	Default Value
Port 1A	DP-34044-2	Delta port	UNSIGNED16	RW	0x0032
Port 1B					
Port 2A					
Port 2B					
Port 3A					
Port 3B					
Port 4A					
Port 4B					
Port 5A	DP-34044-1, -2	Delta port	UNSIGNED16	RW	0x0032
Port 5B					
Port 6A					
Port 6B					
Port 7A					
Port 7B					
Port 8A					
Port 8B					
FREQ_1		Delta frequency			
FREQ_2					
FREQ_3					
FREQ_4					

Programming/Firmware Notes

All modules are capable of in-the-field firmware updates with the use of the xtremeDB Programming Kit (DP-34005-12).

- The Block Tool is the software used to configure xtremeDB blocks. Please reference the [Block Tool Quickstart Guide](#) for instructions.
- DPLoader is the software used to download the firmware to xtremeDB blocks. Please reference the [DPLoader Quickstart Guide](#) for instructions.
- DPNPlayer is the software used to parse DPN and SPN into readable numbers and display messages from a CANBUS network. Please reference the [DPNPlayer Quickstart Guide](#) for instructions.

HARDWARE SETUP OPTIONS

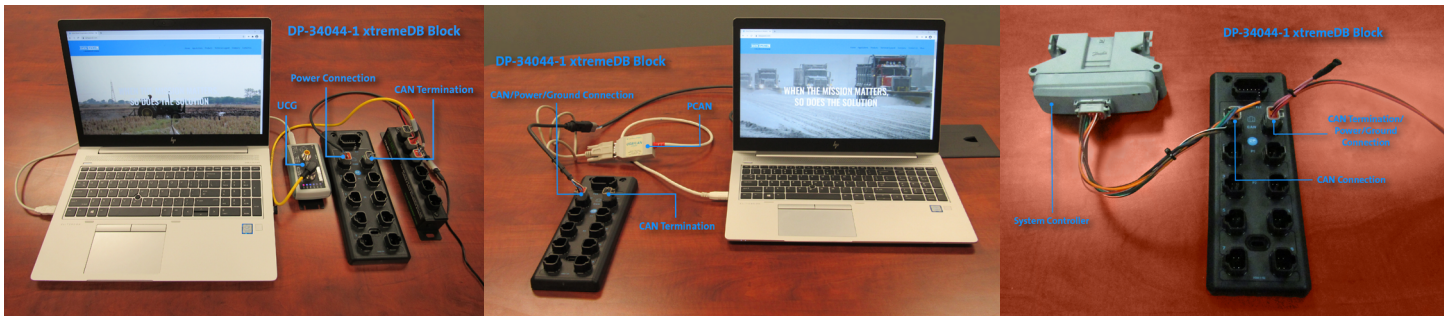

Accepted Accessories

Parts and equipment from other manufacturers can cause functional impairments and product damage. See below for the recommended accessories.



**4 Pin Port Dummy Plug
DP-34042-401**
Seals any unused ports.



**4 Pin CAN Terminating Plug
DP-34042-402**
120 Ohm terminating resistor on pin 2 and pin 4.



DP-34042-405
18 Pin Connector Kit
This connector kit comes with configuration jumpers and sealing plugs.

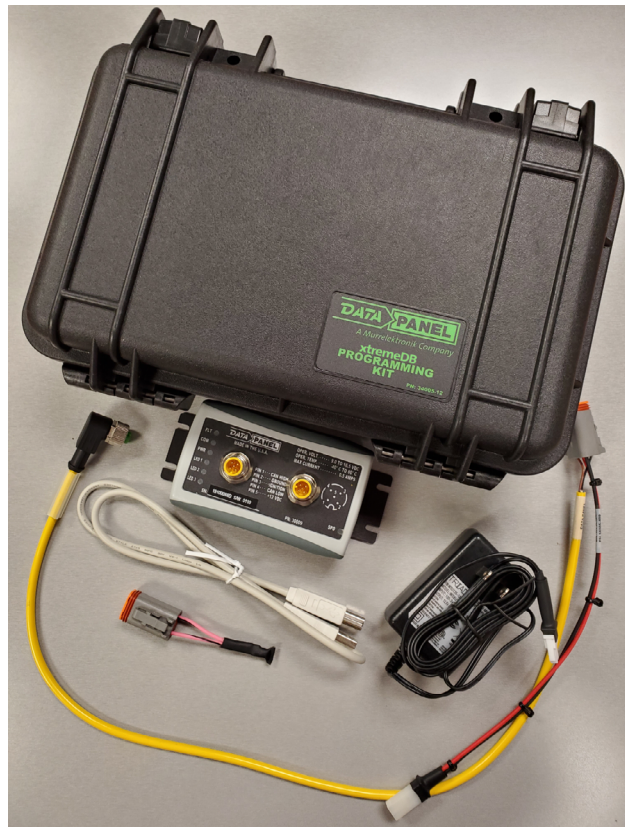

**Programming Kit
DP-34005-12**
Paired with the xtremeDB Block Tool, the DP-34005-12 programming kit makes it possible to send configuration code directly to the xtremeDB block. No need to go hunting through CAN tables; it's all here, ideal for large systems or multiple systems that require a considerable amount of blocks working together. This kit is recommended for CANopen protocols. DPLogic requires the use of this kit. Our software (aside from DPLogic) is compatible with PCAN interfaces, which is ideal for CAN J1939 protocols.

Warranty and Liability Claims

Data Panel Corporation warrants the original purchaser of its products that the products are free of defects in materials and workmanship, when operated under normal conditions and in accordance with accepted industry recommended practices. The standard warranty period is 12 months from the date the product is first put into service but not to exceed 18 months from the date of shipment.

Products must be returned, freight prepaid, to Data Panel for inspection. A Return Material Authorization (RMA) number must be obtained from that location before shipment is made, and clearly indicated on the shipping package. Product must be received within 3 months of the claim as per the requirements of the Returned Goods Process, which is considered to be part of the warranty. Data Panel reserves the right to repair or replace any product found to be under warranty. This warranty policy does not provide for a refund or credit for defective material.

This warranty is null and void if in the judgment of Data Panel, the part had been used in the wrong application, damaged, improperly maintained or repaired, subjected to inappropriate environmental and operating conditions, repaired by a non-approved party without prior authorization, not used in accordance with the operational and service recommendations, or repaired with other than approved parts.

This warranty is in lieu of all other warranties, express or implied and may be varied only by a separate agreement signed by duly authorized representatives of Data Panel Corp. Data Panel makes no warranty of merchantability of fitness for a particular purpose. Data Panel's entire and exclusive liability and the buyers exclusive and sole remedy, in connection with the consequential damages, including loss of use or travel, labor or material cost to remove or reinstall the product, should under no circumstances exceed the original cost for the products for which liability claimed.

Data Panel and Murrelektronik have checked the contents of this technical documentation for conformity with the hardware or software described. Deviations cannot be excluded in individual cases, which is why Data Panel and Murrelektronik exclude the warranty for the correctness of the contents and the liability for errors, in particular for complete conformity. The limitation of liability does not apply insofar as the cause of damage is due to intent and/or gross negligence. Insofar as a material contractual obligation has been breached due to slight negligence, the liability of Data Panel and Murrelektronik shall be limited to the damage typically incurred.

We reserve the right to make technical and content-related changes. We recommend that you check at regular intervals whether this documentation has been updated, as corrections that may become necessary, for example, as a result of technical developments, are regularly incorporated by Data Panel on a regular basis. We are always grateful for suggestions for improvement.

To the maximum extent permitted by applicable law, in no event shall Data Panel, Corp. or Murrelektronik, Inc. be liable for any special, incidental, indirect, or consequential damages whatsoever (including, but not limited to, damages for loss of profits or confidential or other information, for business interruption, for personal injury, for loss of privacy, for failure to meet any duty including of good faith or of reasonable care, for negligence, and for any other pecuniary or other loss whatsoever) arising out of or in any way related to the use of or inability to use the software product, the provision of or failure to provide support services, or otherwise under or in connection with any provision of this End User License, even in the event of the fault, tort (including negligence), strict liability, breach of contract or breach of warranty of Data Panel, Corp or Murrelektronik, Inc. or any supplier, and even if Data Panel, Corp. or Murrelektronik, Inc. or any supplier has been advised of the possibility of such damages.

Message Location Within This Document

Network Protocol	Message ID	Alternate ID	Message Function	Page(s)
J1939 & DPLogic	Command Messages			
	81	0x51h	Port Configuration/Output Control Message 1	28
	82	0x52h	Global Configuration	29
	83	0x53h	I/O Configuration	30-33
	84	0x54h	I/O and PWM(i) Configuration	34-35
	85	0x55h	PMW(i) Configuration	36
	86	0x56h	PMW(i) Configuration	37
	87	0x57h	Counter Configuration	38
	88	0x58h	Output Configuration	39
	89	0x59h	PMW(i) Configuration	39
	90	0x5Ah	PMW(i) Configuration	40
	91	0x5Bh	Variable Transmission Rate	40
	PGN Status Messages			
	61408	(EF(CSA))	Module Status	42
	65510	FFE6	Fault Count	43
	65531	FFFB	Output Status/Input Power Status	44-46
	65532	FFFC	Device Information	47
	65301	FF15	Digital Input Status	48
	65302	FF16	Analog Inputs 1A-2B	49
	65303	FF17	Analog Inputs 3A-4B	49
	65304	FF18	Analog Inputs 5A-6B	50
	65305	FF19	Analog Inputs 7A-8B	50
	65307	FF1B	Frequency Inputs 7A, 8A	51
	65308	*	PWM1	51
	65309	*	PWM2	51
	65310	*	PWM3	52
	65311	*	PWM4	52
	65533	FFFD	Amp Data 1, 3	52
	65523	FF23	Amp Data 1-4/Amp Data 2, 4/Amp Data 1-8	53-54
	65524	FF24	Amp Data 5-8/Amp Data 9-16	54-55
CANopen	Indices			
	1000		Device Type	60
	1001		Error Register	60
	1003		Pre-Defined Error Field	60
	1008		Manufacturer Device Name	60
	1009		Manufacturer Hardware Version	60
	100A		Manufacturer Software Version	60
	1010		Store Parameter Field	60
	1011		Restore Default Parameters	60
	1014		COB-ID EMCY	60
	1015		Inhibit Time Emergency	60
	1017		Producer Heartbeat Time	60

Message Location within this Document (continued)

Network Protocol	Message ID	Message Function	Page(s)
CANopen	Indices		
	1018	Identity Object	60
	1200	Server SDO Parameter 1	60
	1400	Receive PDO Communication Parameter 1	61
	1401	Receive PDO Communication Parameter 2	61
	1402	Receive PDO Communication Parameter 3	61
	1403	Receive PDO Communication Parameter 4	61
	1404	Receive PDO Communication Parameter 5	61
	1600	Receive PDO Mapping Parameter 1	62
	1601	Receive PDO Mapping Parameter 2	62
	1602	Receive PDO Mapping Parameter 3	62
	1603	Receive PDO Mapping Parameter 4	62
	1604	Receive PDO Mapping Parameter 5	62
	1800	Transmit PDO Communication Parameter 1	63
	1801	Transmit PDO Communication Parameter 2	63
	1802	Transmit PDO Communication Parameter 3	63
	1803	Transmit PDO Communication Parameter 4	63
	1804	Transmit PDO Communication Parameter 5	63
	1805	Transmit PDO Communication Parameter 6	63
	1806	Transmit PDO Communication Parameter 7	63
	1807	Transmit PDO Communication Parameter 8	64
	1808	Transmit PDO Communication Parameter 9	64
	1809	Transmit PDO Communication Parameter 10	64
	180A	Transmit PDO Communication Parameter 11	64
	180B	Transmit PDO Communication Parameter 12	64
	1A00	Transmit PDO Mapping Parameter 1	65
	1A01	Transmit PDO Mapping Parameter 2	65
	1A02	Transmit PDO Mapping Parameter 3	65
	1A03	Transmit PDO Mapping Parameter 4	65
	1A04	Transmit PDO Mapping Parameter 5	65
	1A05	Transmit PDO Mapping Parameter 6	65
	1A06	Transmit PDO Mapping Parameter 7	66
	1A07	Transmit PDO Mapping Parameter 8	66
	1A08	Transmit PDO Mapping Parameter 9	66-67
	1A09	Transmit PDO Mapping Parameter 10	67
	1A0A	Transmit PDO Mapping Parameter 11	67
	1A0B	Transmit PDO Mapping Parameter 12	68
	2000	Module Global Configuration	69
	2001	Module I/O Configuration	70-73
	2002	Module PWMi PID Configuration	74
	2003	Module Counter Configuration	75
	2004	Module 10A Limit Configuration	75
	2005	Setpoint OR Module Direction Configuration	75-76

Message Location within this Document (continued)

Network Protocol	Message ID	Message Function	Page(s)
CANopen	Indices		
	3000	Frequency	76
	3001	Setpoint	76
	5000	Response Message	77
	5001	Status Message F1	78-80
	5002	Status Message F2	81
	5003	Status Message Amp	82-84
	5004	Fault Message	84
	6000	Read Input 8-Bit	85
	6200	Write Outputs 8-Bit	86
	6401	Read Analog Input 16-Bit	87-89
	6411	Write Analog Output 16-Bit	90-91
	6423	Analog Input Global Interrupt Enable	91
	6426	Analog Input Interrupt Delta	92-93

Glossary

Term	Definition
Analog Input	A variable voltage or current input from an external sensor
Baud	Abbreviation: Bd = Unit of measurement for speed in data transmission
BUS	Serial data transmission of several participants on the same line
Byte	Term from IEC 61158, corresponds to 1 byte or 8 bits
CAN	Controller Area Network
CANopen	CANopen is a standard of the CiA (CAN in Automation)
COB	Communication Object: Messages are sent in COBs in the network and are considered as communication objects
COB-ID	COB identifier: Each communication object is uniquely identified by the COB ID. The COB-ID identifies the priority of the communication object
Counter	A variable that counts rising edge pulses
DC	Direct Current
Digital Input	Either a positive or ground input, binary ON or OFF
Digital Output	A positive voltage output, binary ON or OFF
EMCY	Emergency messages in CANopen
Enable 24V DC	Enables the low and over voltage fault limits for 24V DC system, otherwise feeding 24V DC to 12V DC system would cause system over voltage error. This is also used for the output overcurrent and short circuit detection.
Encoder	Device using two digital signals to count movement and direction
FREQ1	Sets the global configuration of the frequency for all channels. Value in decimal (40 - 1100 Hz). Example: 0xC8h = 200d = 200 Hz. Outputs will assume the default value if no other value is provided.
ID1	This is used to give a reference number to the node that will be transmitted back in Status Message 1-User ID. Default as 0, please note this User ID is not "the" node ID (node address), please see "Configuring the Node ID" for setting node address.
ISO	International Standards Organization
LED	Light Emitting Diode
Mode 1	Configure all the outputs at the same time, override Command 0x53h.
Mode 2	Configure all the inputs at the same time, override Command 0x53h and 0x54h
Node	Participant in the network
Node ID	Address of CANopen devices in the CAN network
Node SA	Source Address of a J1939 device for identification purposes
PDO	Process Data Object: Object for the exchange of process data between different devices. Cyclic transmission of the process data (PDO) is recommended for analog signals. This way the BUS load can be reduced.
PLC	Programmable Logic Controller
Process	Set of interrelated means and activities that transform inputs into outputs
PWM	Pulse Width Modulation
PWM(i)	PWM(i) or closed loop current compensation is an option that will compensate for changing resistance in electrical output loads. This is particularly useful for valve coils where the mechanical properties of the coils vary greatly with temperature change which can create fluctuation in machine control over the course of the working day. Our PWM(i) outputs will automatically adjust the current output to compensate which means that the electrical setpoint of the output remains more predicatable and constant.
Ratiometric	I/O data presented as a percentage of battery voltage
RO	Read Only or unidirectional data transmission
RW	Read/Write or bidirectional data transmission
SDO	Service Data Object: Objects for accessing and manipulating data in the object dictionary
SYNC	Synchronization object

Mode Operation Examples

INPUT MODE 3

This puts the input into 4-20mA mode with a value of 4,000 - 20,000 = 4,000 - 20,000 micro amps. A word is allocated for this input. The 1st byte is the low byte and the 2nd byte is the high byte.

Table 1																	
Example	Second Byte (High Byte)								First Byte (Low Byte)								
	Bit 8	Bit 7	Bit 6	Bit 5	Bit 4	Bit 3	Bit 2	Bit 1	Bit 8	Bit 7	Bit 6	Bit 5	Bit 4	Bit 3	Bit 2	Bit 1	
4mA																	
4000=	0	0	0	0	1	1	1	1	1	0	1	0	0	0	0	0	

INPUT MODE 4

This puts the input into 0-5V DC mode with a value of 0 - 5,000 = 0 - 5,000mV. A word is allocated for this input. The 1st byte is the low byte and the 2nd byte is the high byte.

Table 2																	
Example	Second Byte (High Byte)								First Byte (Low Byte)								
	Bit 8	Bit 7	Bit 6	Bit 5	Bit 4	Bit 3	Bit 2	Bit 1	Bit 8	Bit 7	Bit 6	Bit 5	Bit 4	Bit 3	Bit 2	Bit 1	
4000mV																	
4000=	0	0	0	0	1	1	1	1	1	0	1	0	0	0	0	0	

INPUT MODE 5

This puts the input into 0-10V DC mode with a value of 0 - 10,000 = 0 - 10,000mV. A word is allocated for this input. The 1st byte is the low byte and the 2nd byte is the high byte.

Table 3																	
Example	Second Byte (High Byte)								First Byte (Low Byte)								
	Bit 8	Bit 7	Bit 6	Bit 5	Bit 4	Bit 3	Bit 2	Bit 1	Bit 8	Bit 7	Bit 6	Bit 5	Bit 4	Bit 3	Bit 2	Bit 1	
7000mV																	
7000=	0	0	0	1	1	0	1	1	0	1	0	1	1	0	0	0	

INPUT MODE 6

This puts the input into 0-32V DC mode with a value of 0 - 32,000 = 0 - 32,000mV. A word is allocated for this input. The 1st byte is the low byte and the 2nd byte is the high byte.

Table 4																	
Example	Second Byte (High Byte)								First Byte (Low Byte)								
	Bit 8	Bit 7	Bit 6	Bit 5	Bit 4	Bit 3	Bit 2	Bit 1	Bit 8	Bit 7	Bit 6	Bit 5	Bit 4	Bit 3	Bit 2	Bit 1	
16000mV																	
16000=	0	0	1	1	1	1	1	0	1	0	0	0	0	0	0	0	

INPUT MODE 9

This puts the input into Ratiometric mode with a value of 0 - 1,000 equaling 0 - 100.0%. This input will show the percentage of voltage being read compared to the source voltage. The 1st byte is the low byte and the 2nd byte is the high byte.

Table 5																	
Example	Second Byte (High Byte)								First Byte (Low Byte)								
	Bit 8	Bit 7	Bit 6	Bit 5	Bit 4	Bit 3	Bit 2	Bit 1	Bit 8	Bit 7	Bit 6	Bit 5	Bit 4	Bit 3	Bit 2	Bit 1	
10.0%																	
100=	0	0	0	0	0	0	0	0	0	1	1	0	0	1	0	0	

OUTPUT MODE 2

This puts the output into PWM control with a value of 0 - 4,000 equaling 0 - 100% of the duty cycle. Two bytes are allocated for each of the PWM control messages with the first 12 bits being used for the value. The first byte and the first 4 bits of the second byte are put together for 12 bit control of the output.

Table 6												
Example	Second Byte (High Byte)				First Byte (Low Byte)							
	Bit 4	Bit 3	Bit 2	Bit 1	Bit 8	Bit 7	Bit 6	Bit 5	Bit 4	Bit 3	Bit 2	Bit 1
50%												
2000	0	1	1	1	1	1	0	1	0	0	0	0

With a value greater than zero in the PWM command and a zero in the direction bit, output A will turn on. If the direction bit is set to a one, output B will turn on.

OUTPUT MODE 3

This puts the output into PWM control with a value of 0 - 1000 equaling 0 - 100.0% of the duty cycle. Two bytes are allocated for each of the PWM control messages with the first 12 bits being used for the value. The first byte and the first 4 bits of the second byte are put together for 12 bit control of the output.

Table 7												
Example	Second Byte (High Byte)				First Byte (Low Byte)							
	Bit 4	Bit 3	Bit 2	Bit 1	Bit 8	Bit 7	Bit 6	Bit 5	Bit 4	Bit 3	Bit 2	Bit 1
50%												
500	0	0	0	1	1	1	1	1	0	1	0	0

With a value greater than zero in the PWM command and a zero in the direction bit, output A will turn on. If the direction bit is set to a one, output B will turn on.

OUTPUT MODE 4

This puts the output into PWM current control with a value of 0 - 4000 equaling 0 - 4000mA. Two bytes are allocated for each of the PWM control messages with the first 12 bits being used for the value. The first byte and the first 4 bits of the second byte are put together for 12 bit control of the output.

Table 8												
Example	Second Byte (High Byte)				First Byte (Low Byte)							
	Bit 4	Bit 3	Bit 2	Bit 1	Bit 8	Bit 7	Bit 6	Bit 5	Bit 4	Bit 3	Bit 2	Bit 1
2000mA												
2000	0	1	1	1	1	1	0	1	0	0	0	0

With a value greater than zero in the PWM command and a zero in the direction bit, output A will turn on. If the direction bit is set to a one, output B will turn on.



A Murrelektronik Company

Data Panel Corporation
181 Cheshire Lane North | Suite 300 | Plymouth, MN 55441
P: 952-941-3511 | F: 952-941-3931 | www.datapanel.com